

The Law Prophesied

R. H. Mount

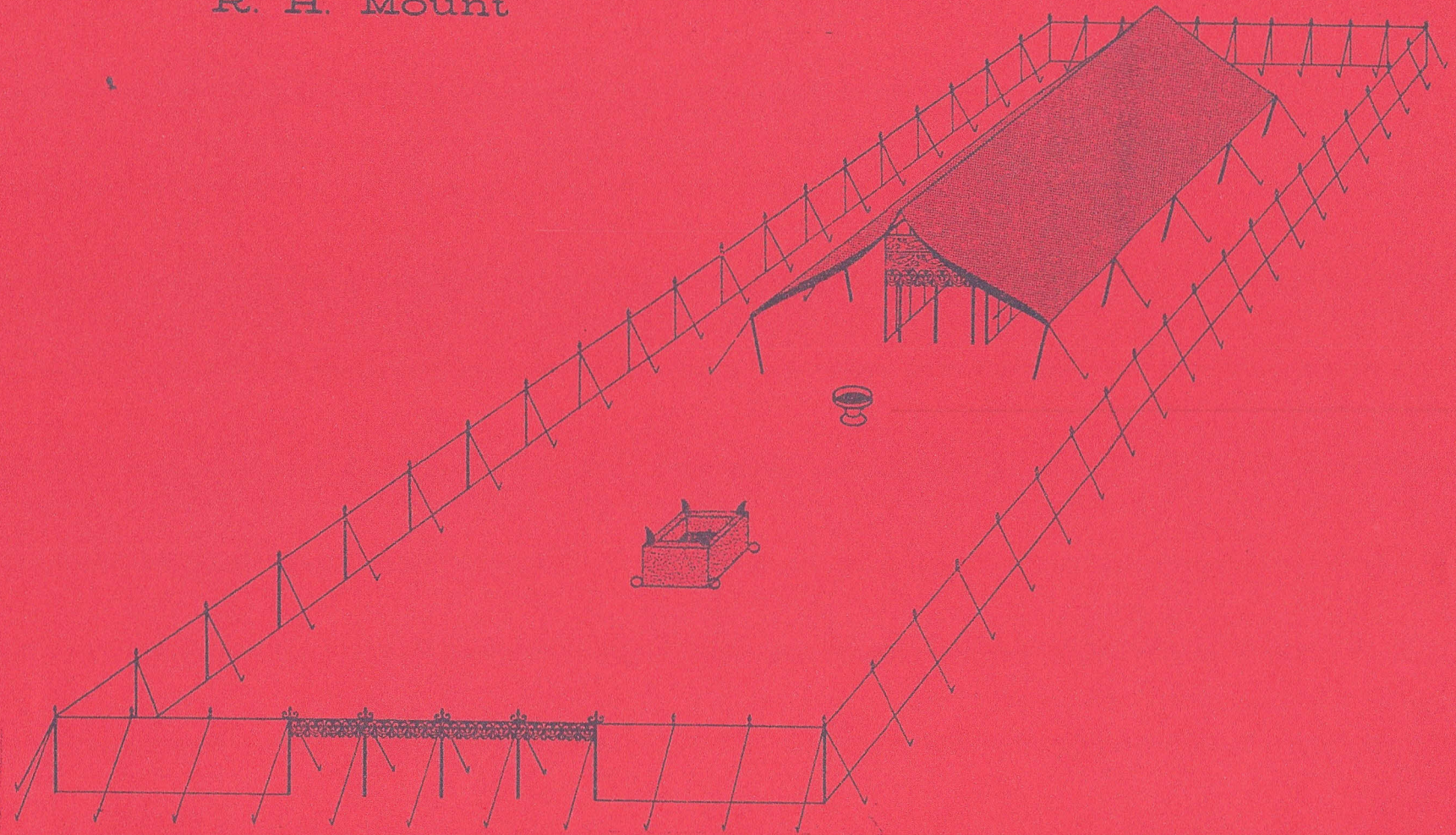

1st edition
© R. H. Mount, Jr., 1962
1st printing-1962-1000
2nd edition
© R. H. Mount, Jr., 1963
2nd printing-1963-2000
3rd printing-1965- 400
4th printing-1965-2100
5th printing-1966-3000
6th printing-1968-1500
7th printing-1970-1500
8th printing-1971-1500

The Law Prophesied

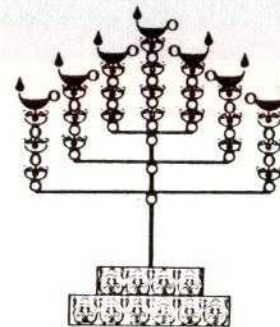

by

R. H. Mount, Jr., M. E.

Mount Publications
Rt. 1, Box 298
Morrison, Fla. 32668

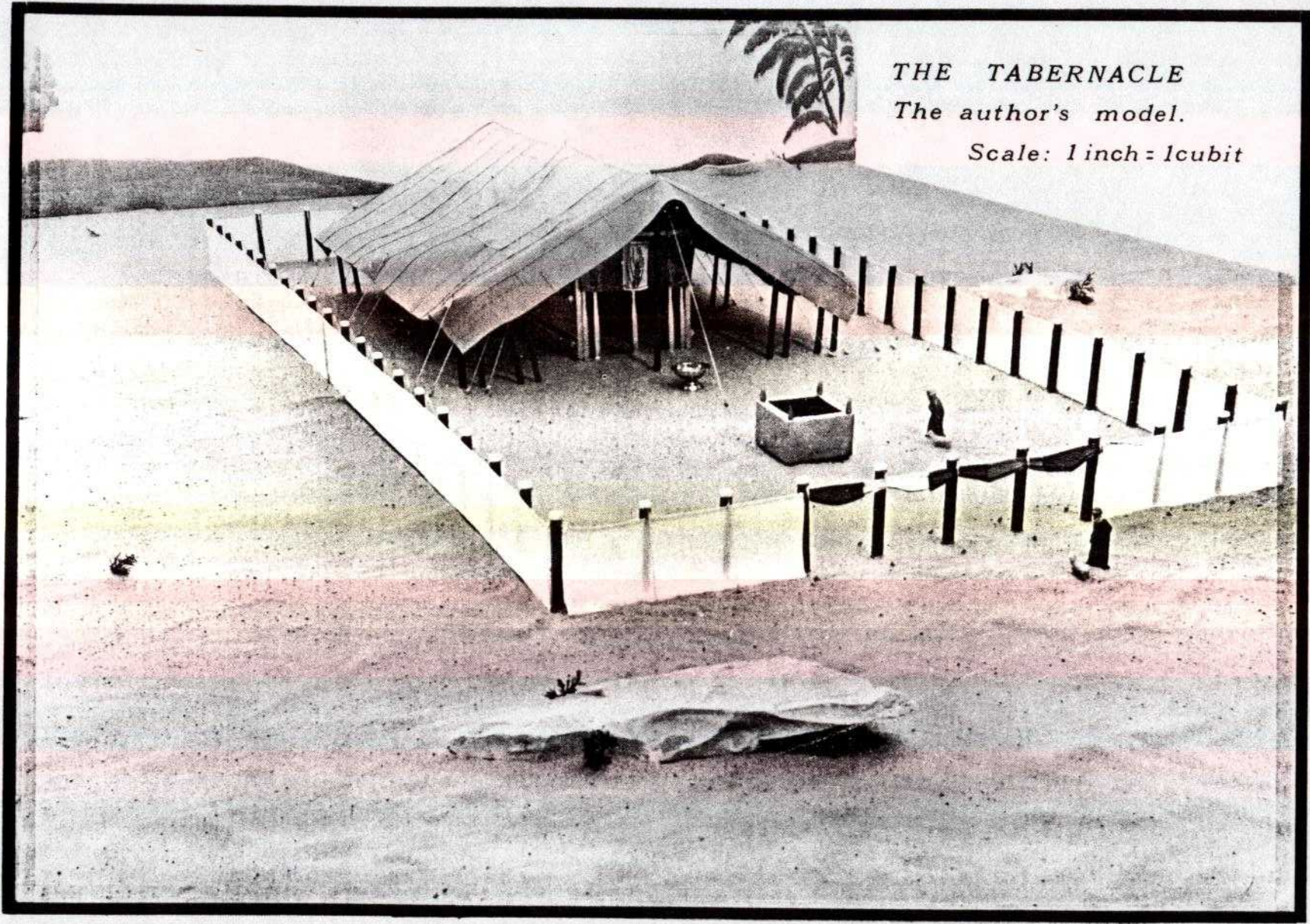

THE TABERNACLE

The author's model.

Scale: 1 inch = 1 cubit

A study of :-

*God's Tabernacle
in*

*Israel's Wilderness
Journey*



★ Architect *was* God

Chief Engineer *was* Moses

Construction } *was* Bezaleel
Engineers } *was* Aholiab

★ Coordinator ★

THE SPIRIT OF GOD

A study of :-

*The most important structure ever
built on earth.*

A study of :-

*The most unusual dwelling ever
erected.*

A study of :-

*The most complex parable ever
recorded in scripture.*

A study of :-

*The most elaborate stage setting
ever constructed.*

A study of :-

*The most amazing drama ever
enacted.*



THE SINAI

from

U.S. SATELLITE, TIROS V

A study of :-

A model of a structure existing in Heaven seen and recorded by two faithful witnesses.

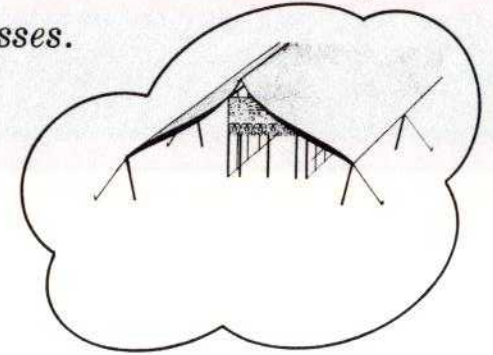

Moses

5 Who serve unto the example and shadow of heavenly things, as Moses was admonished of God when he was about to make the tabernacle: for, See, saith he, *that thou make all things according to the pattern shewed to thee in the mount.*

Heb. 8:5



John

5 And after that I looked, and, behold, the temple of the tabernacle of the testimony in heaven was opened:

Rev. 15:5

PREFACE

Twenty some years ago as a young Christian engineer, I became interested in the subject of the Wilderness Tabernacle. My interest in this wonderful subject has never waned; to the contrary, it has continually increased. Much information was gathered during the construction of four models.

The first model was 50 x 100 inches being to a scale of 1" = 1 cubit. This model had certain size limitations and so a second model was made being to a scale of 3" = 1 cubit. These two models still left much to be desired. My real desire was to first produce a more exact replica and later to produce a far larger, portable model. This desire has been realized, with a model to a scale of 1" = 1 cubit but of real gold, silver, brass, shittim wood, etc., and a reproduction of the veils and furniture the actual size of the originals based on an 18" cubit.

By far the most complex and elaborate parable in the entire Bible is the Wilderness Tabernacle. We find in Hebrews 9:9 it is "a figure (*παραβολή* -parable) for the time present." Here the word "figure" is from the Greek word which is nearly always translated "parable." The word means to throw alongside, or to compare. In other words, the Tabernacle built in the wilderness was a copy of a great Heavenly Tabernacle. Rev. Edmont Hains used to call it "a divinely purposed illustration." Since the Tabernacle in the Wilderness is a copy of the great Heavenly Tabernacle, we would expect this parable, when properly studied, to reveal many of the deep things of God. The purpose of this book is not to re-state the often-repeated applications of this great structure, but rather to attempt to start the

believer into a much more profound study of this greatly neglected portion of the Word of God. It will be shown that the Tabernacle contains the entire plan of salvation and that it is the basis for many of the statements in the New Testament. It is a great picture book, illustrating the plan of salvation before the Bible was written. The rich truths in this structure can never be exhausted.

Added emphasis is placed on the Tabernacle when we realize the emphasis Jesus placed upon the writings of Moses. The subject of the Tabernacle and its related services comprise about 50% of the writings of Moses. Many things Jesus said cannot be understood without a knowledge of the Tabernacle. Jesus said, "Had ye believed Moses, ye would have believed me: for he wrote of me. But if ye believe not his writings, how shall ye believe my words?" John 5:46, 47.

It is my earnest desire that this book will lay for you a foundation in the Law that will make clear otherwise difficult passages. May Luke 24:32 become a reality to you as it was on the road to Emmaus when they said, "Did not our heart burn within us, while he talked with us by the way, and while he opened to us the scriptures?" "And beginning at Moses and all the prophets, he expounded unto them in all the scriptures the things concerning himself." (Luke 24:27)

Ralph H. Mount, Jr.
June 1963

A FEW YEARS AFTER THE CRUCIFIXION - 40 A.D.

LOOKING BACK TO LOOK AHEAD

I'm sure you have a Bible but did you ever stop to think how precious it is? Do you realize how many men gave their lives so that you could have a Bible? God, over a period of about 1500 years, moved men by His Spirit to write our Bible. As our Bible now stands, it has 66 books. Let us look back through the years to a few years after the death of the Lord Jesus and on back to the days of Israel's wandering in the wilderness and yet further back to the days of Israel's bondage in Egypt and see what we find.

GENESIS . . .	II Chronicles . . .	Daniel . . .
Exodus . . .	Ezra	Hosea . . .
Leviticus . . .	Nehemiah	Joel . . .
Numbers . . .	Esther	Amos . . .
Deuteronomy . . .	Job	Obadiah . . .
Joshua . . .	Psalms	Jonah . . .
Judges . . .	Proverbs	Micah . . .
Ruth . . .	Ecclesiastes	Nahum . . .
I Samuel . . .	The Song of Solomon	Habakkuk . . .
II Samuel . . .	Isaiah	Zephaniah . . .
I Kings . . .	Jeremiah	Haggai . . .
II Kings . . .	Lamentations	Zechariah . . .
I Chronicles . . .	Ezekiel	Malachi . . .

IN THE WILDERNESS - 1300 B.C.

TODAY - 1963 A.D.

GENESIS . . .	Isaiah . . .	Epistle to the Romans
Exodus . . .	Jeremiah . . .	I Corinthians . . .
Leviticus . . .	Lamentations	II Corinthians . . .
Numbers . . .	Ezekiel . . .	Galatians
Deuteronomy . . .	Daniel . . .	Ephesians
Joshua . . .	Hosea . . .	Philippians
Judges . . .	Joel . . .	Colossians
Ruth . . .	Amos . . .	I Thessalonians . . .
I Samuel . . .	Obadiah . . .	II Thessalonians . . .
II Samuel . . .	Jonah . . .	I Timothy
I Kings . . .	Micah . . .	II Timothy
II Kings . . .	Nahum . . .	Titus
I Chronicles . . .	Habakkuk . . .	Philemon
II Chronicles . . .	Zephaniah . . .	To the Hebrews . . .
Ezra . . .	Haggai . . .	The Epistle of James
Nehemiah . . .	Zechariah . . .	I Peter
Esther . . .	Malachi . . .	II Peter
Job . . .	MATTHEW	I John
Psalms . . .	Mark . . .	II John
Proverbs . . .	Luke . . .	III John
Ecclesiastes . . .	John . . .	Jude
The Song of Solomon	The Acts . . .	Revelation

GENESIS	
Exodus	Numbers
Leviticus	Deuteronomy

From Adam to Moses (about 2700 years) there was no written Bible. From Moses to Jesus (about 1300 years) there was no New Testament. How then could Moses know of Jesus Christ? Yet, we read: Hebrews 11:24-26

24 By faith Moses, when he was come to years, refused to be called the son of Phâr'-âôh's daughter;

25 Choosing rather to suffer affliction with the people of God, than to enjoy the pleasures of sin for a season;

26 Esteeming the reproach of Christ greater riches than the treasures in Egypt; for he had respect unto the recompence of the reward.

How could Abraham (approximately 2000 B.C.) know of Jesus Christ?

56 Your father Abraham rejoiced to see my day; and he saw it, and was glad.

John 8:56

How could Enoch (approximately 3000 B.C.) preach the second coming of Jesus Christ?

14 And Enoch also, the seventh from Adam, prophesied of these, saying, Behold, the Lord cometh with ten thousands of his saints,

15 To execute judgment upon all, and to convince all that are ungodly among them of all their ungodly deeds which they have ungodly committed, and of all their hard *speeches* which ungodly sinners have spoken against him.

Jude 14, 15

We know that all these men of God knew the plan of salvation and were saved through faith. How?

13 These all died in faith, not having received the promises, but having seen them afar off, and were persuaded of *them*, and embraced *them*, and confessed that they were strangers and pilgrims on the earth.

Hebrews 11:13

Just as God is three persons yet one, so have there been three distinct revelations of God's single plan of redemption. The first such revelation was given in the stars. What is so often referred to with ridicule as the Zodiac, was in the beginning the entire plan of salvation set forth in the stars. Then followed the great earthly picture book which we have

in the Wilderness Tabernacle and finally the written word, our Bible.

When God created the heavens and the earth, He created the sun, moon, and stars. He created these bodies to control the seasons, days, and years but primarily for SIGNS. Beginning with the constellation Virgo, the Virgin, the stars tell the gospel story. The story ends with Leo which depicts the coming of the Lord Jesus Christ to rule on the throne of His father David. The Lord Jesus as the bridegroom comes forth to run His course from His virgin birth to His coming as King of kings and Lord of lords.*

IN the beginning God created the heaven and the earth.

14 ¶ And God said, Let there be lights in the firmament of the heaven to divide the day from the night; and let them be for signs, and for seasons, and for days, and years:

Gen. 1:1, 14

THE heavens declare the glory of God; and the firmament sheweth his handiwork.

2 Day unto day uttereth speech, and night unto night sheweth knowledge.

3 *There is no speech nor language, where their voice is not heard.*

4 Their line is gone out through all the earth, and their words to the end of the world. In them hath he set a tabernacle for the sun,

5 Which is as a bridegroom coming out of his chamber, and rejoiceth as a strong man to run a race.

Rom. 10:18

course

Christ

Ps. 19:1-5

6

The gospel was known throughout the world from the message of the stars as the apostle Paul indicates.

13 For whosoever shall call upon the name of the Lord shall be saved.

Ps. 19:3,4

18 But I say, Have they not heard? Yes verily, their sound went into all the earth, and their words unto the ends of the world.

Rom. 10:13, 18

31 Canst thou bind the sweet influences of Plēi'-ā-dēs, or loose the bands of Ō-rī'-ōn?

← Zodiac

32 Canst thou bring forth Māzz'-ā-rōth in his season? or canst thou guide Ārc-tū'-rūs with his sons?



33 Knowest thou the ordinances of heaven? canst thou set the dominion thereof in the earth?

Job 38: 31-33

The new nation of Israel has issued many postage stamps showing the constellations. On one of the most interesting, shown below, the quotation from the Talmud reads: "I have created 12 constellations of the firmament." The Talmud from which this quotation is taken dates between 200-500 A.D. The quotation at a greater length is as follows: "Resh Lakish said: The Holy One, blessed be He, answered her: My daughter, twelve constellations have I created in the firmament, and for each constellation I have created 30 hosts, and for each host I have created 30 legions, and for each legion I have created 30 cohorts, and for each cohort I have created 30 maniples, and for each maniple I have created 30 camps, and to each camp I have attached 365 thousands of myriads of stars, corresponding to the days of the solar year, and all of them I have created only for thy sake."* From this statement we can compute the number of stars in the heavens. The total is

1,064,340,000,000,000,000. If it proves nothing more, this statement shows that the constellations have long been associated with the nation of Israel. The gospel which once was clearly understood from the stars has now been almost lost in a maze of pagan astrology.



 *... יב מזלות בראתי ברקיע... *
 *... 12 CONSTELLATIONS AU *
 *... FIRMAMENT... BERAKHOT 32b *

ISRAEL 1961

The next great story of the redemption was enacted in Egypt and woven into the picture of the Wilderness Tabernacle. The earthly structure, a copy of the heavenly, was not a church. It was not even a place where all could assemble, for it was very small, being only 75' by 150'. This small structure served approximately 2,500,000 people as their center of worship.

* SONCINO TALMUD- Vol. 16 page 201 Berakoth 32b

THE MAN MOSES

The second revelation of God's single plan of redemption was given through Moses. God chose Moses and by His Spirit made Moses the greatest man this world has ever known. There have been many great men in history but Moses stands high above them all. The life of Moses, more than any other person, had much in common with the life of Jesus. *

Both were miraculously preserved in infancy.

22 And Phâr'-āōh charged all his people, saying, Every son that is born ye shall cast into the river, and every daughter ye shall save alive.

Ex. 1:22

Both spent some childhood in Egypt.

10 And the child grew, and she brought him unto Phâr'-āōh's daughter, and he became her son. And she called his name Moses: and she said, Because I drew him out of the water.

Ex. 2:10

16 ¶ Then Herod, when he saw that he was mocked of the wise men, was exceeding wroth, and sent forth, and slew all the children that were in Bethlehem, and in all the coasts thereof, from two years old and under, according to the time which he had diligently inquired of the wise men.

Matt. 2:16

13 And when they were departed, behold, the angel of the Lord appeareth to Joseph in a dream, saying, Arise, and take the young child and his mother, and flee into Egypt, and be thou there until I bring thee word: for Herod will seek the young child to destroy him.

Matt. 2:13

Both were meek.

3 (Now the man Moses *was* very meek, above all the men which *were* upon the face of the earth.)

Num. 12:3

Both were miraculously sustained in a 40-day fast.

28 And he was there with the LORD forty days and forty nights; he did neither eat bread, nor drink water. And he wrote upon the tables the words of the covenant, the ten commandments.

Ex. 34:28

Both chose out 70 men.

16 ¶ And the LORD said unto Moses, Gather unto me seventy men of the elders of Israel, whom thou knowest to be the elders of the people, and officers over them; and bring them unto the tabernacle of the congregation, that they may stand there with thee.

Num. 11:16

Both chose out 12 men.

23 And the saying pleased me well: and I took twelve men of you, one of a tribe:

Deut. 1:23

5 Tell ye the daughter of Sion, Behold, thy King cometh unto thee, meek, and sitting upon an ass, and a colt the foal of an ass.

Matt. 21:5

THEN was Jesus led up of the Spirit into the wilderness to be tempted of the devil.

2 And when he had fasted forty days and forty nights, he was afterward an hungered.

Matt. 4:1, 2

AFTER these things the Lord appointed other seventy also, and sent them two and two before his face into every city and place, whither he himself would come.

Luke 10:1

AND when he had called unto *him* his twelve disciples, he gave them power *against* unclean spirits, to cast them out, and to heal all manner of sickness and all manner of disease.

Matt. 10:1

As far as scripture is concerned there is no record of either Moses or Jesus ever having been sick or in any way enfeebled.

Both worked great miracles.

20 And Moses and Aaron did so, as the LORD commanded; and he lifted up the rod, and smote the waters that *were* in the river, in the sight of Phâr'-āōh, and in the sight of his servants; and all the waters that *were* in the river were turned to blood.

Ex. 7:20

7 Jesus saith unto them, Fill the waterpots with water. And they filled them up to the brim.

8 And he saith unto them, Draw out now, and bear unto the governor of the feast. And they bare *it*.

9 When the ruler of the feast had tasted the water that was made wine,

John 2:7-9

In death, their bodies were never found.

9 Yet Michael the archangel, when contending with the devil he disputed about the body of Moses, durst not bring against him a railing accusation, but said, The Lord rebuke thee.

Jude 9

3 And they entered in, and found not the body of the Lord Jesus.

Luke 24:3



Every writer of the New Testament referred to Moses.

Matthew Matt. 17:23
Mark Mark 9:4
Luke Luke 9:30
John John 1:17

Paul Rom. 5:14
James Acts 15:21
Peter Acts 3:22
Jude Jude 9

Three witnesses saw Moses alive after his death.



AND after six days Jesus taketh Peter, James, and John his brother, and bringeth them up into an high mountain apart,

2 And was transfigured before them: and his face did shine as the sun, and his raiment was white as the light.

3 And, behold, there appeared unto them Moses and Ê-li'-ās talking with him.

Matt. 17:1-3

Three witnesses recorded this fact.

AND after six days Jesus taketh Peter, James, and John his brother, and bringeth them up into an high mountain apart,

2 And was transfigured before them: and his face did shine as the sun, and his raiment was white as the light.

3 And, behold, there appeared unto them Moses and Ê-li'-ās talking with him.

Matt. 17:1-3



2 ¶ And after six days Jesus taketh *with him* Peter, and James, and John, and leadeth them up into an high mountain apart by themselves: and he was transfigured before them.

3 And his raiment became shining, exceeding white as snow; so as no fuller on earth can white them.

4 And there appeared unto them Ê-li'-ās with Moses: and they were talking with Jesus.

Mark 9:2-4



28 ¶ And it came to pass about an eight days after these sayings, he took Peter and John and James, and went up into a mountain to pray.

29 And as he prayed, the fashion of his countenance was altered, and his raiment *was* white and glistening.

30 And, behold, there talked with him two men, which were Moses and E-li'-ās:

Luke 9:28-30



Fifteen books in the Old Testament, beside the Pentateuch, refer to Moses and his writings.

So great is the man Moses that Jesus referred to him by name 19 times.

45 Do not think that I will accuse you to the Father: there is *one* that accuseth you, *even* Moses, in whom ye trust.

46 For had ye believed Moses, ye would have believed me: for he wrote of me.

47 But if ye believe not his writings, how shall ye believe my words?

John 5:45-47

Matt. 8:4	Mark 7:10	Luke 16:29	John 6:32
Matt. 19:8	Mark 10:3	Luke 16:31	John 7:19
Matt. 23:2	Mark 12:26	Luke 20:37	John 7:22
Mark 1:44	Luke 5:14	Luke 24:44	John 7:23

Both Moses and Jesus were lawgivers.

19 Did not Moses give you the law, and *yet* none of you keepeth the law? Why go ye about to kill me?

John 7:19

43 ¶ Ye have heard that it hath been said, Thou shalt love thy neighbour, and hate thine enemy.

44 But I say unto you, Love your enemies, bless them that curse you, do good to them that hate you, and pray for them which despitefully use you, and persecute you;

Matt. 5:43, 44

Both were prophets.

15 ¶ The LORD thy God will raise up unto thee a Prophet from the midst of thee, of thy brethren, like unto me; unto him ye shall hearken;

19 And it shall come to pass, *that* whosoever will not hearken unto my words which he shall speak in my name, I will require *it* of him.

Deut. 18:15, 19

22 For Moses truly said unto the fathers, A prophet shall the Lord your God raise up unto you of your brethren, like unto me; him shall ye hear in all things whatsoever he shall say unto you.

23 And it shall come to pass, *that* every soul, which will not hear that prophet, shall be destroyed from among the people.

Acts 3:22, 23

Both were mediators.

19 Wherefore then *serveth* the law? It was added because of transgressions, till the seed should come to whom the promise was made; *and it was* ordained by angels in the hand of a mediator.

Gal. 3:19

15 And for this cause he is the mediator of the new testament, that by means of death, for the redemption of the transgressions *that were* under the first testament, they which are called might receive the promise of eternal inheritance.

Heb. 9:15

God chose the man Moses to write nearly one-fifth of the entire Bible. God showed to Moses the Heavenly Tabernacle and entrusted to him the making of the earthly duplicate. God instructed Moses in the setting up of all the laws of sacrifice which became a great drama enacted on the greatest stage setting ever built. These sacrifices and their ritual as well as their setting told in picture form the entire plan of salvation.

Here the similarity between Moses and Jesus comes to an end. Great as Moses was he fades into insignificance in the light of the One who is the TRUE LIGHT.

17 For the law was given by Moses, *but* grace and truth came by Jesus Christ.

John 1:17

A NIGHT TO BE MUCH OBSERVED

There are many reasons we should study the Tabernacle.

1. It was God's earthly dwelling place.
2. It was the most important structure ever built by man; past, present, and future.
3. It was a duplicate of an existing Heavenly Tabernacle.
4. Its details are twice repeated in the Scripture and therefore it must be important.
5. The structure together with related services comprises approximately one half of the books of the Law: Genesis, Exodus, Leviticus, Numbers, and Deuteronomy, all written by Moses.
6. It forms the basis for understanding much New Testament truth.
7. It was in effect a great picture book pointing to Jesus Christ and the entire plan of salvation before the Bible was written.
8. It is itself the largest and most complex parable in Scripture. Hebrews 9:9, says it was a "figure" which is the Greek word "parable."
9. It is divine proof of the Scriptures, for it is called The Tabernacle of Witness, or The Tabernacle of Proof in Acts 7:44. Its mathematical exactness is amazing.

The word "Tabernacle" means dwelling place. The Biblical Tabernacle was a very small structure which was the center for Israel's worship, the dwelling place of God in the midst of the nation of Israel. It was approximately 75' x 150', completely portable, and built of gold, silver, brass, shittim wood, linen, goats' hair and skins. (Figure 1)

THE TABERNACLE of WITNESS-

[The most important *FIGURE* in the Bible. Heb. 9:9]
[A *COPY* of *HEAVENLY THINGS*. Heb. 8:5 asv.]

Comprises $\frac{1}{2}$ of the Books of the Law.

"Great peace have they that love
thy **LAW**; and they have no occasion
of stumbling." Ps. 119:165 asv.

© R. H. Mount, Jr., 1962

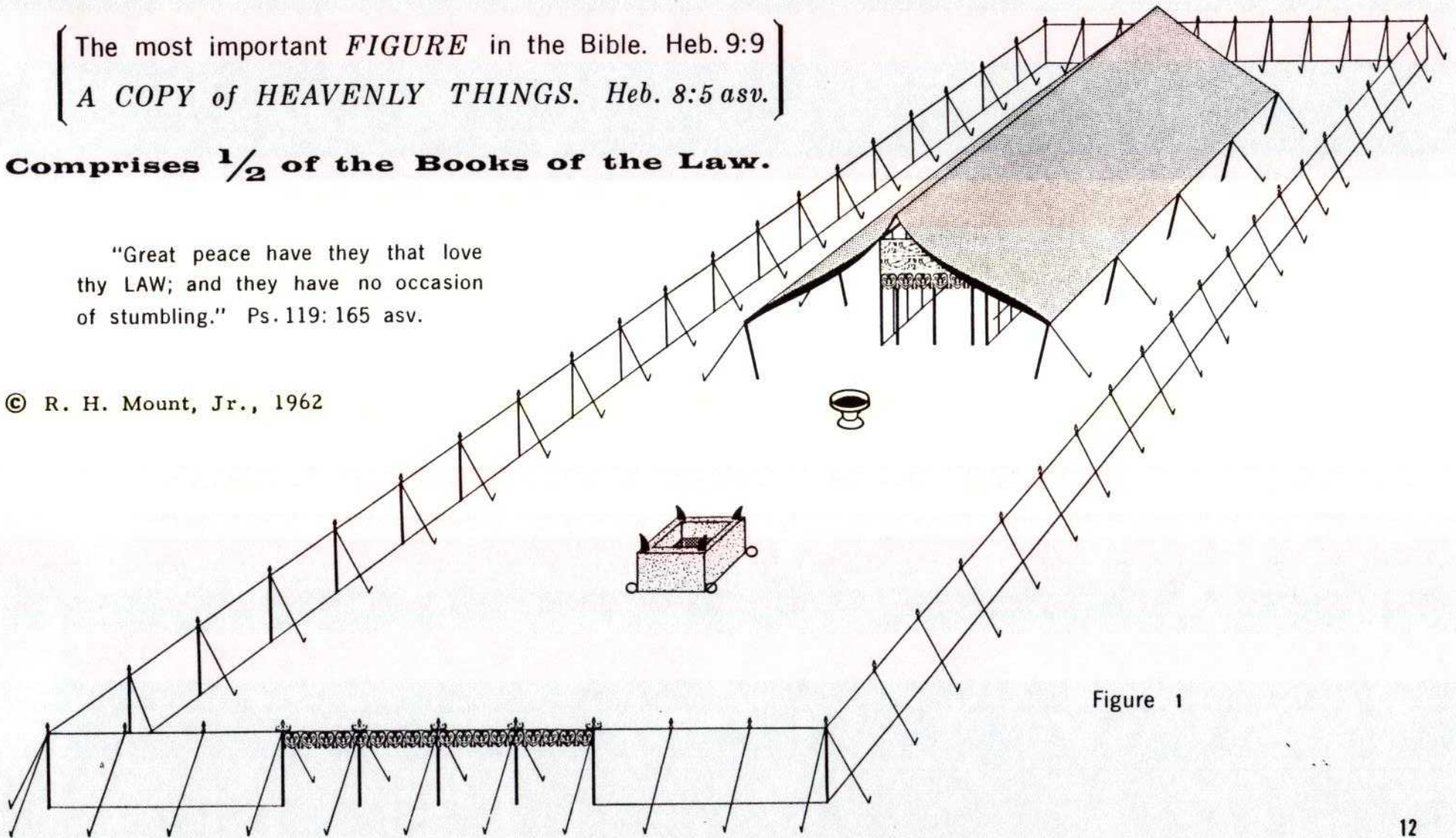

Figure 1

Many years had passed since God had changed Jacob's name to Israel. Jacob and his sons had gone down into Egypt; there, things had gone well for the children of Israel. But with the prosperity of Israel came the envy and jealousy and fear of the Egyptians. Israel was soon put in bondage to the Egyptians, and Israel cried to God for deliverance. After many years God heard their cry and raised up Moses to deliver them. Water turned to blood; frogs infested the land; lice came upon man and beast; flies filled the houses; murrain infected the cattle; boils broke out on man and beast; hail and fire smote man, beast and crops; locusts devastated the land; and then a thick darkness filled the land for three days. Then came, a night to be remembered. This was the Lord's Passover. The angel of death was to pass through the land and every home without blood on the door posts and lintel was to be visited, and the firstborn would die.

42 It is a night to be much observed unto the LORD for bringing them out from the land of Egypt: this is that night of the LORD to be observed of all the children of Israel in their generations.

Ex. 12:42

Each father picked out a lamb, sufficient for all his household, without a blemish, a male, a year old, without a broken bone. At even, the lamb was killed and roasted; its blood was put in the threshold of the doorway. With a branch of hyssop dipped in the blood, he sprinkled both the side posts and the lintel of the door. Inside, under the blood was perfect safety. There, each Israelite fed on the lamb, a picture of that Lamb that was to come. The Lamb of God was a male. He, too, was in the prime of life, without sin, and on Calvary's cross His legs were not broken, that this very prophecy might be fulfilled. Just as the lamb was sufficient for each household, so God's Lamb was sufficient for whosoever will may come. As each Israelite ate in

perfect safety, the angel of death saw on the door posts and lintel, not just the blood of ANY lamb, but, in shadow, the blood from the nail-pierced hands and feet and thorn-pierced brow of THE LAMB OF GOD.

To escape the plague of death, the directions were simple. Take a male lamb, a year old, without spot or blemish, with no bone broken. Kill the lamb and put its blood in a basin. Then, with a branch of hyssop, strike blood onto the door posts and lintel. Then, God said, "WHEN I SEE THE BLOOD I WILL PASS OVER YOU." (Ex. 12:13)

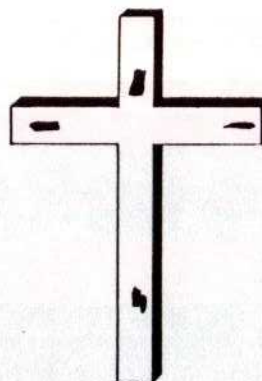
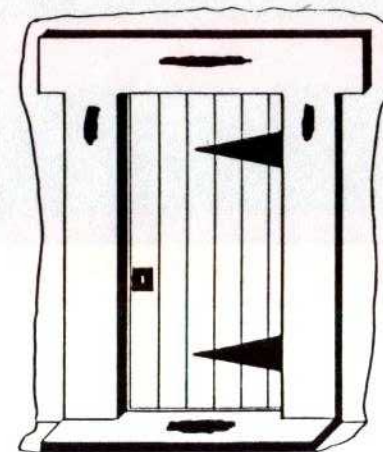

Here, indeed, we find our first clear picture of the cross: Blood in the basin or threshold from His nail-pierced feet; Blood on the door posts from His nail-pierced hands; Blood on the lintel from His thorn-pierced brow. The passover lamb was a picture of Christ. "For even Christ our passover is sacrificed for us." (1 Cor. 5:7) Christ is God's lamb, a male, in the prime of life; without spot or blemish, with no bone broken.

As all of the first-born in every home which had not applied the blood of a lamb died, a great cry went up from a grieving Egyptian nation. After that terrible night, day dawned upon a free nation of Israel. Out of bondage, out across the Red Sea as God by a miracle parted the waters came a nation of more than 2,500,000 people. The Israelites' journey led to Mt. Sinai. Miracle upon miracle was wrought by God as He led them through the wilderness.

Then God called Moses up to Mt. Sinai; and there God not only gave Moses the ten commandments, but, in addition, showed Moses the Heavenly Tabernacle and told him to be sure to follow the pattern exactly.

9 According to all that I shew thee, *after* the pattern of the tabernacle, and the pattern of all the instruments thereof, even so shall ye make it.

40 And look that thou make *them* after their pattern, which was shewed thee in the mount.

Ex. 25:9, 40

The Bible had not yet been given. The Wilderness Tabernacle with its services was a great picture book showing the plan of salvation.

If one is to study the spiritual truths, it is of utmost importance that the structure itself be correctly understood. A faulty structure will automatically lead to faulty conclusions. When the Bible takes many chapters to give a careful description, repeating many details over and over, one cannot over emphasize the details of the structure. As we study critically the details, may it be with a view to making a more accurate structure with which to unfold the spiritual fountain which flows from this unique building.

AN OFFERING THAT WAS TOO MUCH

When the poor, oppressed Israelites were delivered from their years of bondage, they had very little of this world's goods. God knew that an earthly model of the Heavenly Tabernacle, even though small, would take a lot of material. Then, too, the people needed a great many materials for their own use if they were to start life as a free people. God provided for their need.

2 Speak now in the ears of the people, and let every man borrow of his neighbour, and every woman of her neighbour, jewels of silver, and jewels of gold.

← ask

3 And the LORD gave the people favour in the sight of the Egyptians. Moreover the man Moses *was* very great in the land of Egypt, in the sight of Phâr'-aōh's servants, and in the sight of the people.

Ex. 11:2, 3



The word "borrow" should be the word "ask" as in the American Standard Version. Many of the Egyptians favored Moses and were not in sympathy with the way the Israelites had been treated. God so prepared the hearts of the Egypt-

ians that the Egyptians "let them have what they asked." This is the correct reading in the ASV. of the word "lent" in the King James text.

35 And the children of Israel did according to the word of Moses; and they borrowed of the Egyptians jewels of silver, and jewels of gold, and raiment:

36 And the LORD gave the people favour in the sight of the Egyptians, so that they lent unto them *such things as they required*. And they spoiled the Egyptians.

Ex. 12:35, 36



asked

When the people arrived at Mt. Sinai and the time came to bring their offerings with which to build the Tabernacle, all the needed material was available. With a willing heart the people brought their gifts: gold, silver, brass, shittim wood, linen, goats' hair and skins. Gold, brought largely in the form of jewelry, heads the list of the gifts they brought. As we start the construction, we note that the specifications sometimes read "gold" and sometimes "pure gold." The word for "pure" is also often translated "clean." It would seem that "pure gold" does not necessarily mean 24-karat but rather means "clean" or free of all impurities. One of the major impurities in gold jewelry is lead. All impurities including lead must be removed before gold can be beaten very thin. You will notice "pure gold" is specified when fine beaten work is involved. To beat gold, requires that it be heated to a cherry red and then quenched, usually today in wood alcohol. This softens the gold. As beating continues, the gold hardens, and must again be softened. When the gold has been beaten very thin, it may be that the vein of lead will be the entire thickness of the plate. Gold melts at 1947° F, lead melts at 626° F. You can readily see that the vein of lead will melt out the next time the gold is heated to soften it for further beating, leaving a great gap in the plate.

Thus in overlaying the furniture pure gold is specified, whereas rings and the overlay of staves and boards, etc., do not require this quality.

While the silver brought was brought willingly, this gift did have certain specifications.

13 This they shall give, every one that passeth among them that are numbered, half a shē'-kēl after the shekel of the sanctuary: (a shekel is twenty gē'-rāhš:) an half shekel shall be the offering of the LORD.

14 Every one that passeth among them that are numbered, from twenty years old and above, shall give an offering unto the LORD.

15 The rich shall not give more, and the poor shall not give less than half a shē'-kēl, when they give an offering unto the LORD, to make an atonement for your souls.

Ex. 30:13-15



Brass is an alloy of copper and zinc. This Hebrew word means either copper, brass, or bronze. Bronze is an alloy of copper and tin. Many utensils of copper, brass, and bronze were brought out of Egypt. Note especially the brass or bronze mirrors of the women which were used to make the brasen laver.

8 ¶ And he made the laver of brass, and the foot of it of brass, of the looking glasses of the women assembling, which assembled at the door of the tabernacle of the congregation.

Ex. 38:8

mirrors →



Very fine linen was produced from the flax in Egypt. Finished linen was brought from Egypt along with the gold, silver, and brass. (Ex. 35:23) Some was dyed blue, some purple, some scarlet, and some was bleached white. That there were four distinct colors of linen used, seems quite clear from Ex. 39:2, 3. "And he made the ephod of gold, blue, and purple, and scarlet, and fine twined linen. And they did beat the gold into thin plates, and cut it into wires, to work it in the BLUE, and in the PURPLE, and in the SCARLET, and in the FINE (white) LINEN, with cunning work." These are also referred to as the "four colors of the Temple ('fine linen, blue, scarlet, and purple')" by Dr. Alfred Edersheim in his book, THE TEMPLE, page 58.

Some of the linen was spun by the women from thread they had brought. Here again, we see the distinct colors. "And all the women that were wise hearted did spin with their hands, and brought that which they had spun, both of BLUE, and of PURPLE, and of SCARLET, and of FINE LINEN." (Ex. 35:25)

Some goats' hair was spun by the women. Some finished goats' hair cloth had been brought from Egypt.

23 And every man, with whom was found blue, and purple, and scarlet, and fine linen, and goats' hair, and red skins of rams, and badgers' skins, brought them.

* * *

25 And all the women that were wise-hearted did spin with their hands, and brought that which they had spun, both of blue, and of purple, and of scarlet, and of fine linen.

26 And all the women whose heart stirred them up in wisdom spun goats' hair.

Ex. 35:23, 25, 26

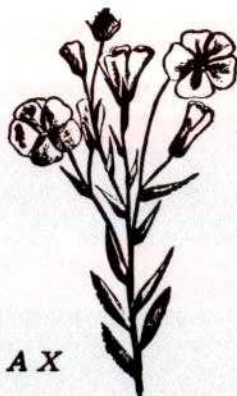

FLAX

The rams' skins dyed red were an easy item to supply either having been brought from Egypt or obtained from their own flocks.

The next material presents a little more difficulty. The word translated "badgers' skins" seems very definitely to have been incorrectly translated. The American Standard Version shows "sealskins" with a marginal note "porpoise-skins." The Revised Standard Version shows "goatskins." An interpreter reading from a Spanish translation said it was "raccoon skins." Obviously, these animals are not alike.

A DICTIONARY OF THE BIBLE, by William Smith, LL.D, on page 73 states, "The ancient versions seem nearly all agreed that it denotes not an animal but a color, either black or sky-blue. The Badger is not found in the Bible lands."

ANTIQUITIES OF THE JEWS, by Josephus, Chpt. VI, "sheep-skins, some of them dyed of a blue color, and some of a scarlet.....(And speaking of the blue skins) And great was the surprise of those who viewed these curtains at a distance, for they seemed not at all to differ from the colour of the sky."

THE SEPTUAGINT has skins (ὑακίνθινα) hyacinth colored skins. Hence, the sky blue of Josephus.

It appears from this evidence alone, and much more could be introduced, that the top skins were, regardless of animal, dyed BLUE.

Reference is often made to the fact that badgers' skins were used for shoes and Ez. 16:10 is quoted, "I clothed thee also with broided work, and shod thee with badgers' skins." Here, again the word is the same in the Hebrew but is mistranslated. Note that these are not the shoes of a hard-working peasant or shepherd; these are the beautiful shoes of a queen, not drab and dull, but pretty and, as the Septuagint again renders the word, (ὑακινθῶν) hyacinth color.

The wood used is a very durable material of the acacia species. There are several varieties of the acacia in the

Sinai peninsula. The rest of the offerings brought were not used in the structure itself but in its operation and for making the garments of the High Priest.

5 ¶ And they spake unto Moses, saying, The people bring much more than enough for the service of the work, which the LORD commanded to make.

6 And Moses gave commandment, and they caused it to be proclaimed throughout the camp, saying, Let neither man nor woman make any more work for the offering of the sanctuary. So the people were restrained from bringing.

7 For the stuff they had was sufficient for all the work to make it, and too much.

Ex. 36:5-7



HOLY THINGS

In Exodus 25, we have the first details of the Tabernacle as they were given to Moses. The sequence in which this description is given may be quite significant whereas the recording of the construction sequence beginning in Ex. 36 may have no significance at all since construction in all likelihood began simultaneously on all of the parts.

The drawings which follow should greatly simplify the description given in words. The word "ark" is a word which means "chest" and in Genesis 50:26 is translated "coffin". This was a large wooden box overlaid inside and outside with pure gold. The dimensions are shown on the drawing. A cubit was originally the distance from a man's elbow to the tip of the longest finger. There are many figures given for the length of a cubit but for ease of calculation, we will use 18" as the standard cubit for the Tabernacle.

10 ¶ And they shall make an ark of shittim wood: two cubits and a half shall be the length thereof, and a cubit and a half the breadth thereof, and a cubit and a half the height thereof.

11 And thou shalt overlay it with pure gold, within and without shalt thou overlay it, and shalt make upon it a crown of gold round about.

Ex. 25:10, 11

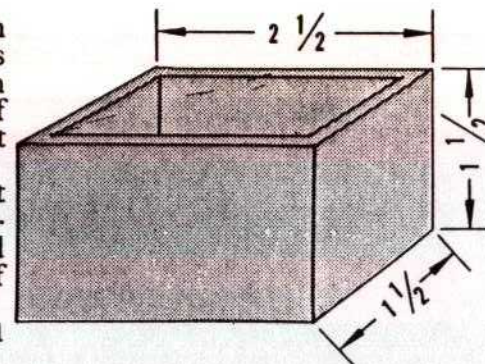

Around the top of the ark was a golden crown. The shape of the crown is not given in our text but the Septuagint gives the crown as gold-twisted involutes, perhaps

something similar to the drawing. The four cast-gold rings for the staves were probably very low on the sides or even on the feet of the ark. The American Standard Version reads, "And thou shalt cast four rings of gold for it, and put them in the four FEET thereof." (Ex. 25:12) The staves to carry the ark were to be put in the rings and left in. (Ex. 25:15) In the ark was placed the tables of the covenant. (Ex. 25:16) From Hebrews 9:4 we learn that in all there were three objects placed in the ark, Aaron's rod, a pot of manna and the tables of the covenant.

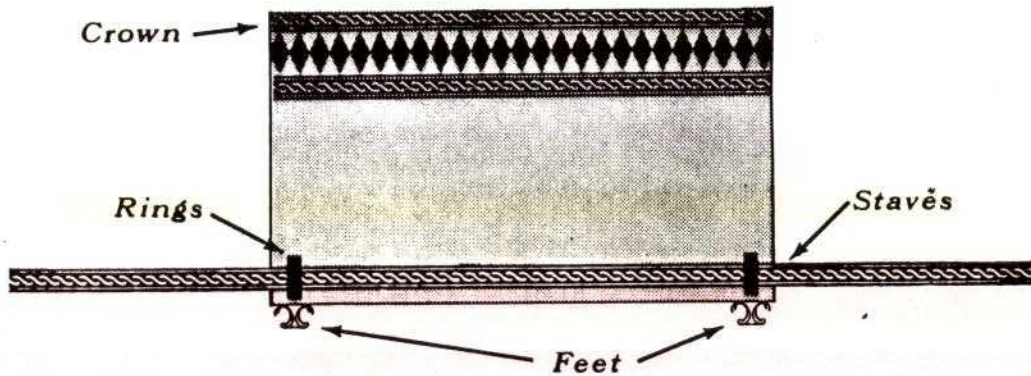

12 And thou shalt cast four rings of gold for it, and put *them* in the four corners thereof; and two rings *shall be* in the one side of it, and two rings in the other side of it.

13 And thou shalt make staves of shittim wood, and overlay them with gold.

14 And thou shalt put the staves into the rings by the sides of the ark, that the ark may be borne with them.

15 The staves shall be in the rings of the ark: they shall not be taken from it.

16 And thou shalt put into the ark the testimony which I shall give thee.

Ex. 25:12-16

Over the top of the ark was placed a plate of gold called the Mercy Seat. This is a peculiar name for this plate since it is not a seat of any kind. We will discuss this a little later. Beaten cherubim were placed at either end with their wings stretched on high, covering the mercy seat and their faces toward the mercy seat. Paul in Hebrews 9:5 passes the cherubim without any further details, thus very little is known, nor is it possible to produce a copy of them. One thing of which we can be quite sure is that they were very small. When it is considered that one cubic foot of gold weighs 1200 pounds, and all the gold in the entire structure was only 5482 pounds, it does not permit cherubim four and five feet high. (Ex. 38:24) A great weight of gold in the cherubim would have made the ark so top heavy that it would have been almost impossible to handle.

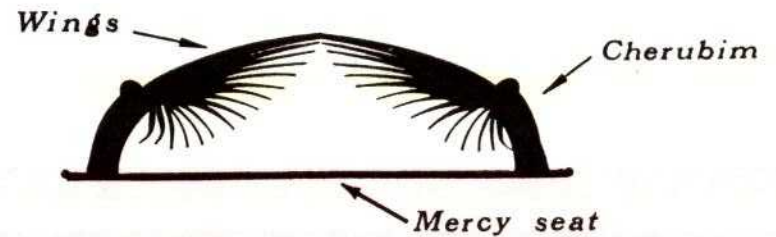

17 And thou shalt make a mercy seat of pure gold: two cubits and a half *shall be* the length thereof, and a cubit and a half the breadth thereof.

18 And thou shalt make two chër'-û-bîms of gold, of beaten work shalt thou make them, in the two ends of the mercy seat.

19 And make one cherub on the one end, and the other cherub on the other end: *even* of the mercy seat shall ye make the chër'-û-bîms on the two ends thereof.

20 And the chër'-û-bîms shall stretch forth *their* wings on high, covering the mercy seat with their wings, and their faces *shall look* one to another; toward the mercy seat shall the faces of the cherubims be.

Ex. 25:17-20

Here between the cherubim on the mercy seat was sprinkled blood from a bullock ONCE, and blood from a goat ONCE, each year. (Lev. 16) Here, it was that God met with Israel "from above the mercy seat, from between the two cherubims." (Ex. 25:22)

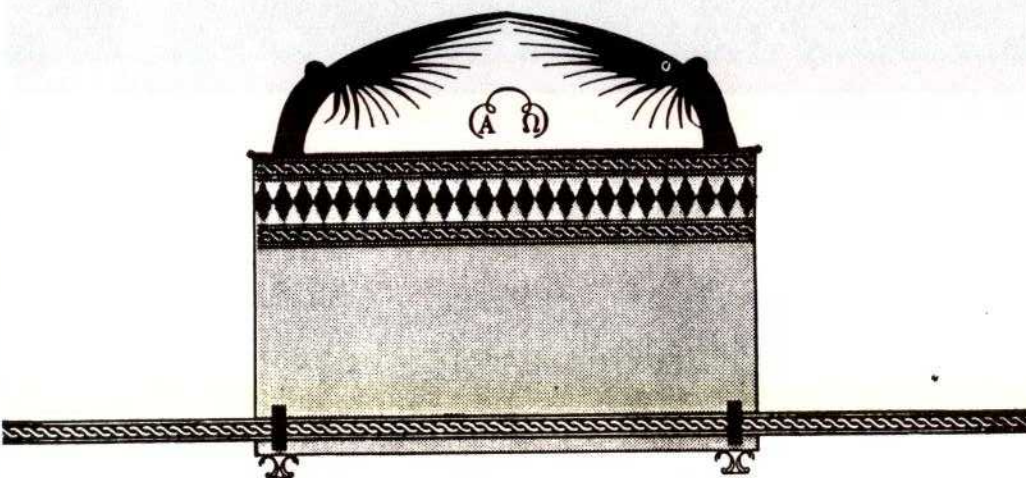

21 And thou shalt put the mercy seat above upon the ark; and in the ark thou shalt put the testimony that I shall give thee.

22 And there I will meet with thee, and I will commune with thee from above the mercy seat, from between the two chër'-ū-bims which are upon the ark of the testimony, of all things which I will give thee in commandment unto the children of Israel.

Ex. 25:21, 22

The golden table, as it is often called, because it was overlaid with pure gold was made of shittim wood. This table is often referred to as the Table of Shewbread, because there was always placed on this table 12 loaves of unleavened bread. NO ONE EVER ATE FROM THIS TABLE. Each Sabbath, the bread was changed and then the priests could eat the shewbread that had been removed. Even David, when he ate the shewbread unlawfully, did not eat bread from the table itself. "So the priest gave him hallowed bread: for there was no bread there but the shewbread, that was TAKEN FROM BEFORE THE LORD, to put hot bread in the day when it was taken away." (1 Sam. 21:6) (See also Matt. 12:3, 4)

23 ¶ Thou shalt also make a table of shittim wood: two cubits shall be the length thereof, and a cubit the breadth thereof, and a cubit and a half the height thereof.

24 And thou shalt overlay it with pure gold, and make thereto a crown of gold round about.

25 And thou shalt make unto it a border of an hand breadth round about, and thou shalt make a golden crown to the border thereof round about.

Ex. 25:23-25

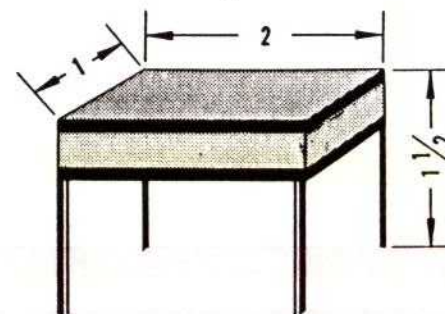

The dimensions of the table are given on the drawing, above. There was a crown of gold, around the top of the table then a border of a hand breadth, approximately 4" and then another crown. As in the case of the ark of the covenant the exact shape of the crown is not known. The position of the crowns has long been a point of interest. Was there a crown around the top of the table and then the border on the table surface inside the crown and then still inside another crown or was it as the drawing shows; a crown, farther down a border, and still farther down another crown?

First, let us consider the size of the bread. Each loaf was made of two tenth parts of an ephah (Lev. 24:5 ASV), or about two omers of wheat. This is about 10 pints and according to Dr. Edersheim in his book, THE TEMPLE, they were 5 x 10 hand breadths. They were so large they were folded up at the ends. Thus, folded, they reached from one side of the table to the other and therefore the crowns had to be one below the other on the sides of the

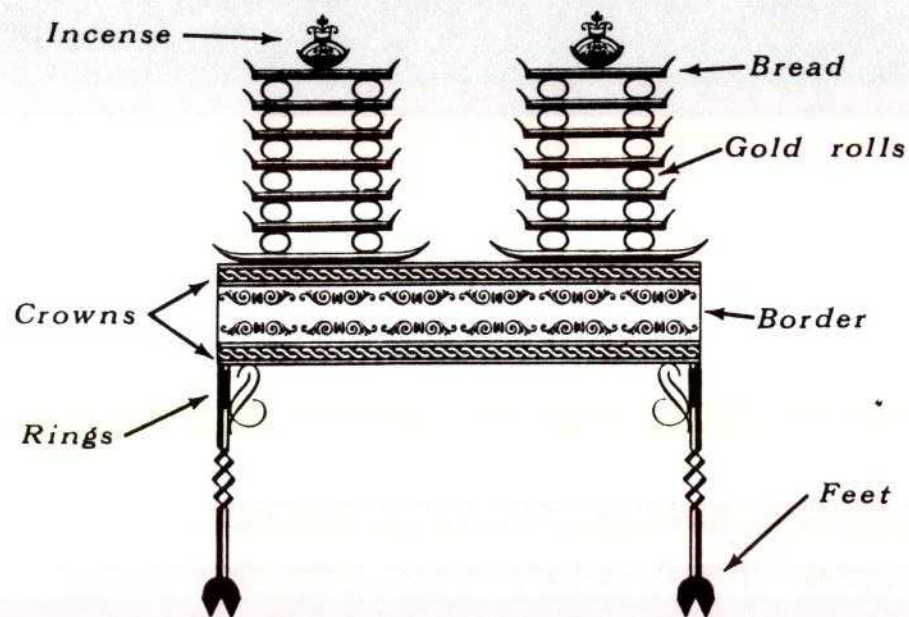

table as shown in the drawing. The 12 loaves were in two piles not lengthwise rows. Between each loaf were placed gold rolls to keep the bread dry. The piles shown in the drawing are turned at right angles to their actual position so you may see approximately how they looked. Further, exact details are in Dr. Edersheim's work, THE TEMPLE. These loaves were actually "perforated cakes" as understood by the Hebrew word, "challah". These cakes were made without leaven, for in the Scripture leaven always represents sin. Further, to properly bake an unleavened

cake it had to be perforated. There is one more note in regards to the loaves. Dr. Edersheim states that each one was anointed with oil in the form of a cross.

The staves were put through rings close up to the lower crown for the border. (Ex. 25:27) The utensils were probably used for carrying and making the bread as well as making the incense.

26 And thou shalt make for it four rings of gold, and put the rings in the four corners that are on the four feet thereof.

27 Over against the border shall the rings be for places of the staves to bear the table.

28 And thou shalt make the staves of shittim wood, and overlay them with gold, that the table may be borne with them.

29 And thou shalt make the dishes thereof, and spoons thereof, and covers thereof, and bowls thereof, to cover withal: of pure gold shalt thou make them.

30 And thou shalt set upon the table shewbread before me alway.

Ex. 25:26-30

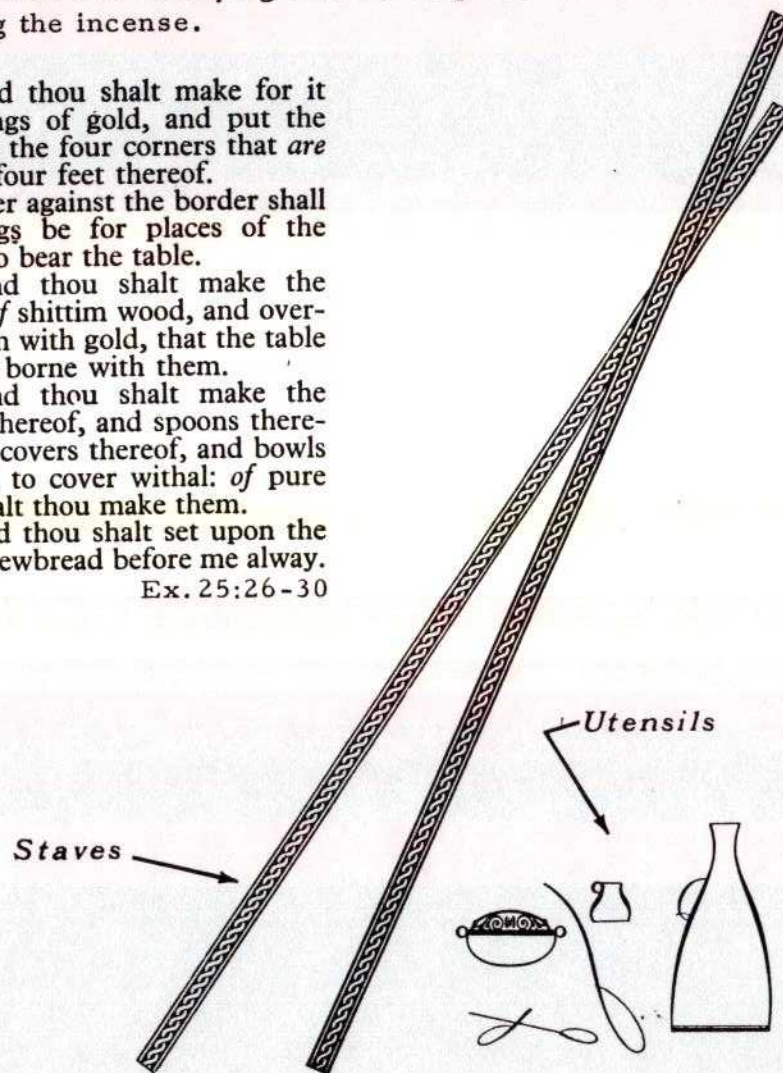

In Ex. 25:31, we find the word "candlestick". This should read "lampstand" as there were seven lamps burning olive oil, (Ex. 25:37) not candles. It was of one talent of gold, perhaps 229 pounds troy weight. (Drawing below). Three branches extended from each side of the center stem. The decorations were knops, bowls, and flowers. These were not mere decorations, but were very important to the understanding of the meaning of the lampstand. It is carefully stated that the bowls were shaped like almonds.

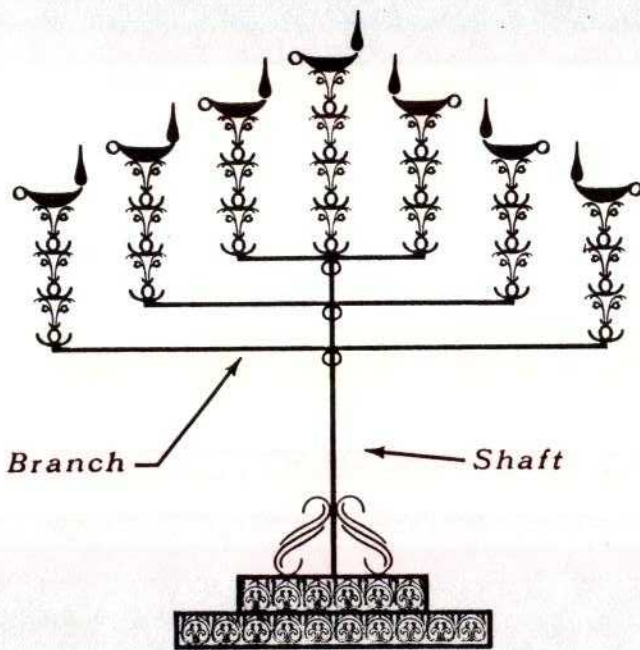

31 ¶ And thou shalt make a candlestick of pure gold: of beaten work shall the candlestick be made: his shaft, and his branches, his bowls, his knops, and his flowers, shall be of the same.

32 And six branches shall come out of the sides of it; three branches of the candlestick out of the one side, and three branches of the candlestick out of the other side:

Ex. 25:31, 32

33 Three bowls made like unto almonds, with a knop and a flower in one branch; and three bowls made like almonds in the other branch, with a knop and a flower: so in the six branches that come out of the candlestick.

34 And in the candlestick shall be four bowls made like unto almonds, with their knops and their flowers.

35 And there shall be a knop under two branches of the same, and a knop under two branches of the same, and a knop under two branches of the same, according to the six branches that proceed out of the candlestick.

36 Their knops and their branches shall be of the same: all it shall be one beaten work of pure gold.

37 And thou shalt make the seven lamps thereof: and they shall light the lamps thereof, that they may give light over against it.

38 And the tongs thereof, and the snuffdishes thereof, shall be of pure gold.

39 Of a talent of pure gold shall he make it, with all these vessels.

40 And look that thou make them after their pattern, which was shewed thee in the mount.

Ex. 25:33-40

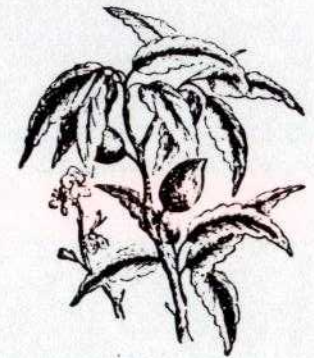

Almonds

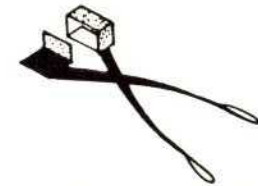

Tongs



Snuffdishes

Now you will notice Aaron's rod. (Nu. 17:8) It budded (the knops), and blossomed (the flowers), and yielded almonds (the bowls). Thus the lampstand represents the tribe of Levi, even as Aaron was a Levite. The lampstand had its own utensils called tongs and snuffdishes. (Ex. 25:38) Tongs were used to extinguish the lamps, and the snuffdishes were trays to receive the burnt wick that was trim-

med off. It is of utmost importance to note that the lamps were lit each evening and put out each morning. This procedure was followed continually, it does not mean the lights burned continually. "And when Aaron lighteth the lamps at even." (Ex. 30:8) "...to cause the lamps to burn continually (each night). Without the veil of the testimony, in the tabernacle of the congregation, shall Aaron order it from the evening unto the morning before the Lord continually." (Lev. 24:23) (See also 1 Sam. 3:3)

2 Command the children of Israel, that they bring unto thee pure oil olive beaten for the light, to cause the lamps to burn continually.

3 Without the veil of the testimony, in the tabernacle of the congregation, shall Aaron order it from the evening unto the morning before the LORD continually: *it shall be a statute for ever in your generations.*

4 He shall order the lamps upon the pure candlestick before the LORD continually.

Lev. 24:2-4

8 And when Aaron lighteth the lamps at even, he shall burn incense upon it, a perpetual incense before the LORD throughout your generations.

Ex. 30:8

The size of the lampstand in the Tabernacle is not known but, assuming the temple to have followed the same proportions, the lampstand would have been 3 cubits or 4 1/2 feet high.

The lamps used pure beaten olive oil as a fuel. (Lev. 24:2) In Temple days, at least, it appears that the wicks for the lamps were made from the soiled garments of the priests. *

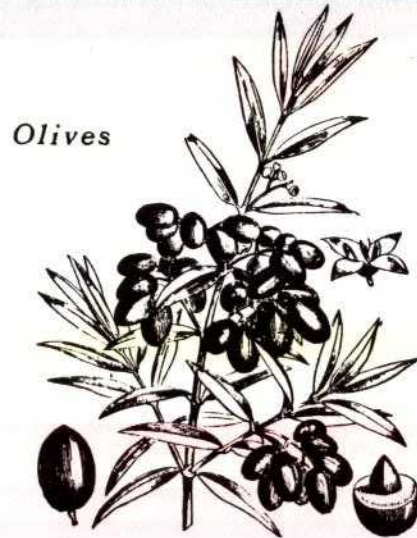

Now, in the sequence of the text, we come to the description of the brasen altar. It is often called the altar of sacrifice or the altar of burnt offering. This, the largest of the pieces of furniture, stood in the court just inside the court gate. A hollow shittim wood frame was first made

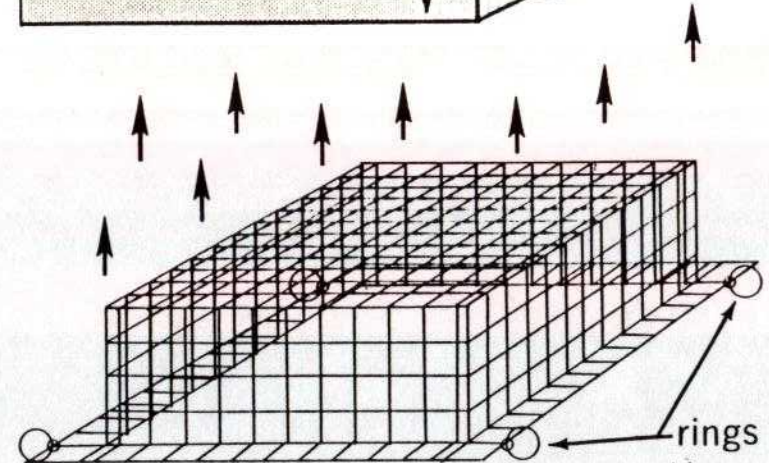
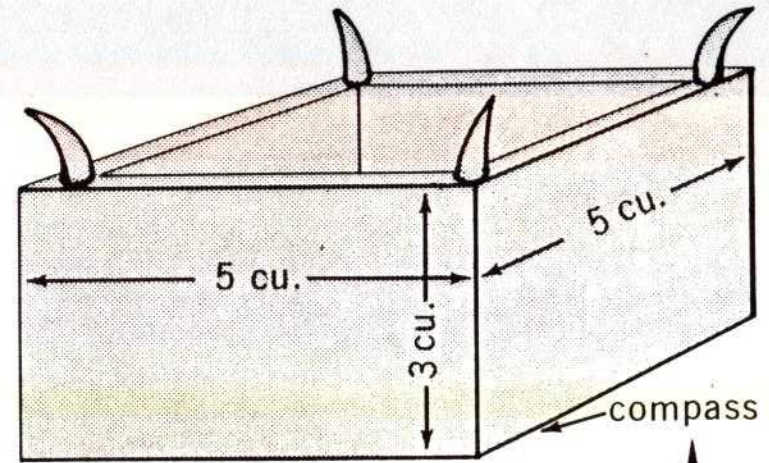

GRATE

7 1/2 feet square and 4 1/2 feet high. Horns were fastened on the four corners, probably also made of shittim wood. (Ex. 27:2) Nothing is given in regards to the shape of the horns. Then, this frame was overlaid with great brass plates. Thus, the altar itself was finished. Next were given the service utensils: pans, shovels, basins, fleshhooks, and firepans. Not connected to the altar, completely separate, was a grate. The grate had a peculiar shape and is best understood by a study of the drawing. Notice that the construction of the grate is very unique; it allowed for its ready removal from the altar for cleaning purposes, and the grate bars under the altar lifted the altar to provide draft. The wooden frame was, no doubt, soon charred and the great brass plates stood as a hollow box channel square.

AND thou shalt make an altar of shittim wood, five cubits long, and five cubits broad; the altar shall be foursquare: and the height thereof shall be three cubits.

2 And thou shalt make the horns of it upon the four corners thereof: his horns shall be of the same: and thou shalt overlay it with brass.

3 And thou shalt make his pans to receive his ashes, and his shovels, and his basins, and his fleshhooks, and his firepans: all the vessels thereof thou shalt make of brass.

4 And thou shalt make for it a grate of network of brass; and upon the net shalt thou make four brasen rings in the four corners thereof.

5 And thou shalt put it under the compass of the altar beneath, that the net may be even to the midst of the altar.

6 And thou shalt make staves for the altar, staves of shittim wood, and overlay them with brass.

7 And the staves shall be put into the rings, and the staves shall be upon the two sides of the altar, to bear it.

8 Hollow with boards shalt thou make it: as it was shewed thee in the mount, so shall they make it.

Ex. 27:1-8

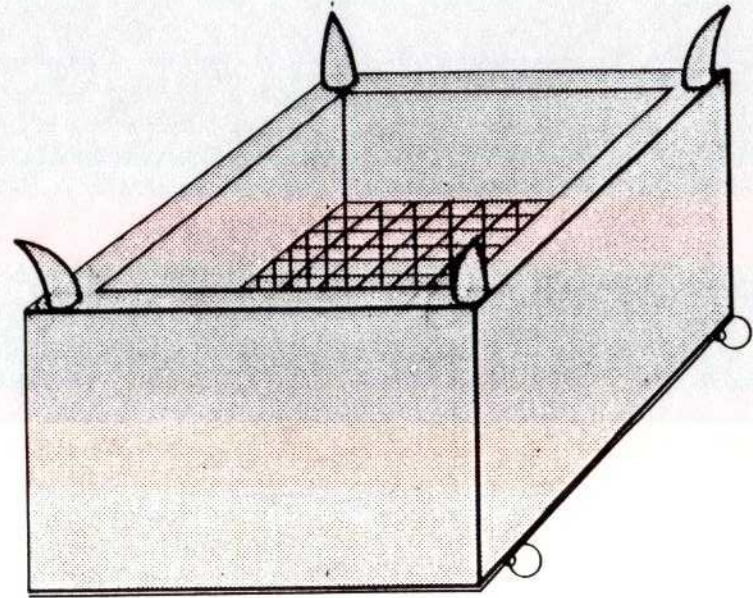

This was a heavy piece to move and required many men. Mr. Adams, a returned missionary from China, now at Ben Lippen School in Asheville, North Carolina, gave us a probable explanation as to how this was done. We have illustrated the explanation in the drawing.

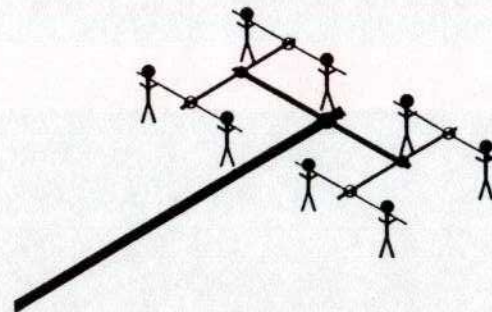
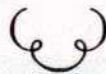

Possible method of carrying one end of a stave. By adding H's additional men may be used.

The description of the altar of incense or the golden altar follows next in the description of the items of furniture. It was three feet high and eighteen inches square. This altar was in the holy place just before the veil. Every morning and evening the priests burned incense as representative of their prayers. (Rev. 8:3, 4; Ps. 141:2) Just as the ark of the covenant, it too was made of shittim wood and overlaid with pure gold. On the top were four horns and around the top a gold crown. Staves were placed through two rings on diagonal corners in order to carry it.

Zacharias, the father of John the Baptist, was burning incense on a similar altar in the temple when Gabriel brought the message that Zacharias was to have a son. Zacharias was a priest of the tribe of Levi. (Luke 1:5-23)

AND thou shalt make an altar to burn incense upon: of shittim wood shalt thou make it.

2 A cubit shall be the length thereof, and a cubit the breadth thereof; foursquare shall it be: and two cubits shall be the height thereof: the horns thereof shall be of the same.

3 And thou shalt overlay it with pure gold, the top thereof, and the sides thereof round about, and the horns thereof; and thou shalt make unto it a crown of gold round about.

4 And two golden rings shalt thou make to it under the crown of it, by the two corners thereof, upon the two sides of it shalt thou make it; and they shall be for places for the staves to bear it withal.

5 And thou shalt make the staves of shittim wood, and overlay them with gold.

Ex. 30:1-5

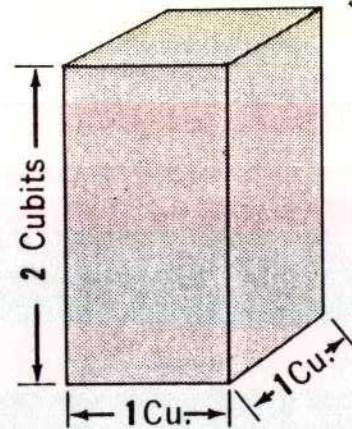

6 And thou shalt put it before the veil that is by the ark of the testimony, before the mercy seat that is over the testimony, where I will meet with thee.

7 And Aaron shall burn thereon sweet incense every morning: when he dresseth the lamps, he shall burn incense upon it.

8 And when Aaron lighteth the lamps at even, he shall burn incense upon it, a perpetual incense before the LORD throughout your generations.

9 Ye shall offer no strange incense thereon, nor burnt sacrifice, nor meat offering; neither shall ye pour drink offering thereon.

10 And Aaron shall make an atonement upon the horns of it once in a year with the blood of the sin offering of atonements: once in the year shall he make atonement upon it throughout your generations: it is most holy unto the LORD.

Ex. 30:6-10

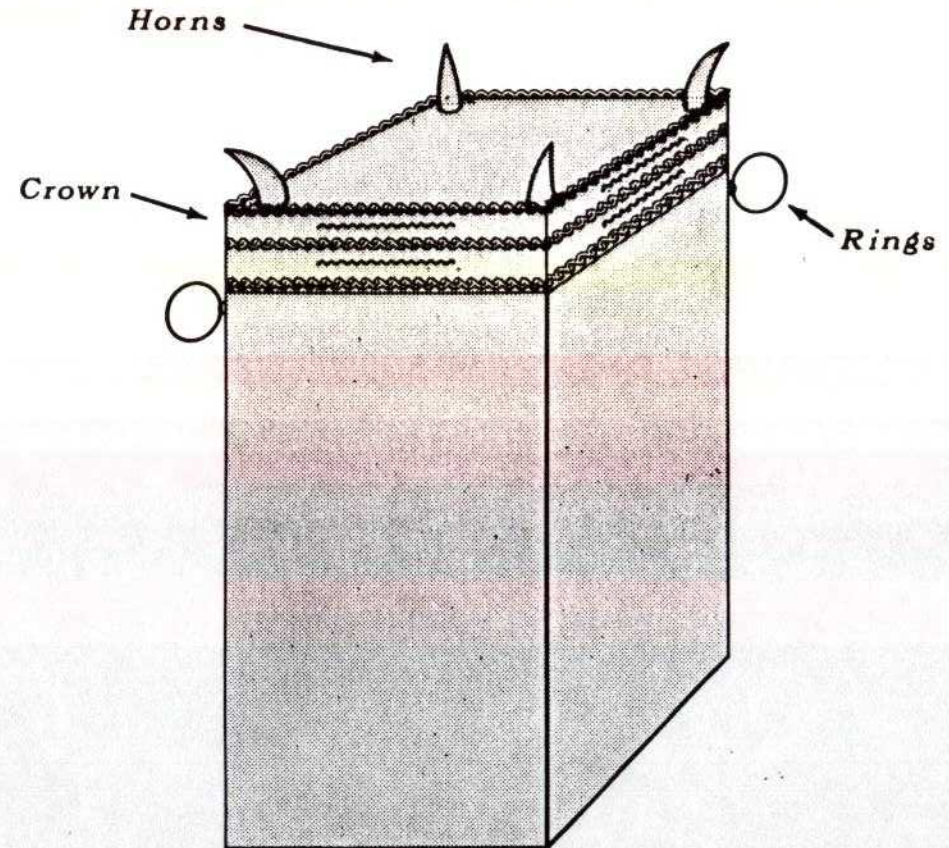

The last of the pieces to be described is the laver of brass. Except for the fact that it contained water and was used in ceremonial washing and was made of the brass mirrors of the women, very little is known. It is usually understood to be round. Since the water would be dipped out and poured over the hands and feet there is no necessity for a separate "foot" to contain water to wash the feet.* In fact, the priest probably placed his hand on his foot as the water was poured over them. It is preferable to understand the word "foot" as "base", the laver coming apart for more convenient moving. The brass mirrors were a special gift, not included in the general offering, perhaps by the women that had worked on the construction or maybe as the Septuagint says, "women that were fasting."



Laver

17 ¶ And the LORD spake unto Moses, saying,

18 Thou shalt also make a laver of brass, and his foot also of brass, to wash *withal*: and thou shalt put it between the tabernacle of the congregation and the altar, and thou shalt put water therein.

19 For Aaron and his sons shall wash their hands and their feet thereat:

20 When they go into the tabernacle of the congregation, they shall wash with water, that they die not; or when they come near to the altar to minister, to burn offering made by fire unto the LORD:

21 So they shall wash their hands and their feet, that they die not: and it shall be a statute for ever to them, *even* to him and to his seed throughout their generations.

Ex. 30:17-21

THE TABERNACLE, ITS TENT, and ITS COVERING

We now come to a very critical part of this entire structure. Failure to properly understand this piece has led for many years to a very improper construction.

Now, read very carefully, "Moreover thou shalt make the tabernacle with ten curtains." (Ex. 26:1) The word "with" is in italics in the King James and tells us immediately that there is no such word in the Hebrew text. We therefore, should read, "Moreover thou shalt make the tabernacle, ten curtains." The word Tabernacle, has in the construction, a very limited use. The Tabernacle is not the entire structure but simply the 10 linen curtains. When these 10 curtains are fastened together they become a unit. "And IT shall be one tabernacle." (Ex. 26:6) And why not, this linen curtain represents Christ and it is in Christ that God dwelt. "For in him dwelleth all the fulness of the Godhead bodily." (Col. 2:9)

MOREOVER thou shalt make the tabernacle *with* ten curtains of fine twined linen, and blue, and purple, and scarlet: *with* chër'-û-bîms of cunning work shalt thou make them.

2 The length of one curtain shall be eight and twenty cubits, and the breadth of one curtain four cubits: and every one of the curtains shall have one measure.

3 The five curtains shall be coupled together one to another; and *other* five curtains shall be coupled one to another.

4 And thou shalt make loops of blue upon the edge of the one curtain from the selvedge in the coupling; and likewise shalt thou make in the uttermost edge of *another* curtain, in the coupling of the second.

5 Fifty loops shalt thou make in the one curtain, and fifty loops shalt thou make in the edge of the curtain that *is* in the coupling of the second; that the loops may take hold one of another.

6 And thou shalt make fifty taches of gold, and couple the curtains together with the taches: and *it* shall be one tabernacle.

Ex. 26:1-6

* THE TEMPLE, Alfred Edersheim, D. D., Ph. D.

This may be shown to be the case even more clearly. Notice, the "bill of material" beginning in Ex. 35:11. "The tabernacle, his tent, and his covering, his taches----"etc.. You will find no reference to the 10 linen curtains because they are, the Tabernacle. This is also true in Ex. 39:33 and Ex. 40:18. Having now determined that the 10 linen curtains are the Tabernacle, let us proceed further with the cons-

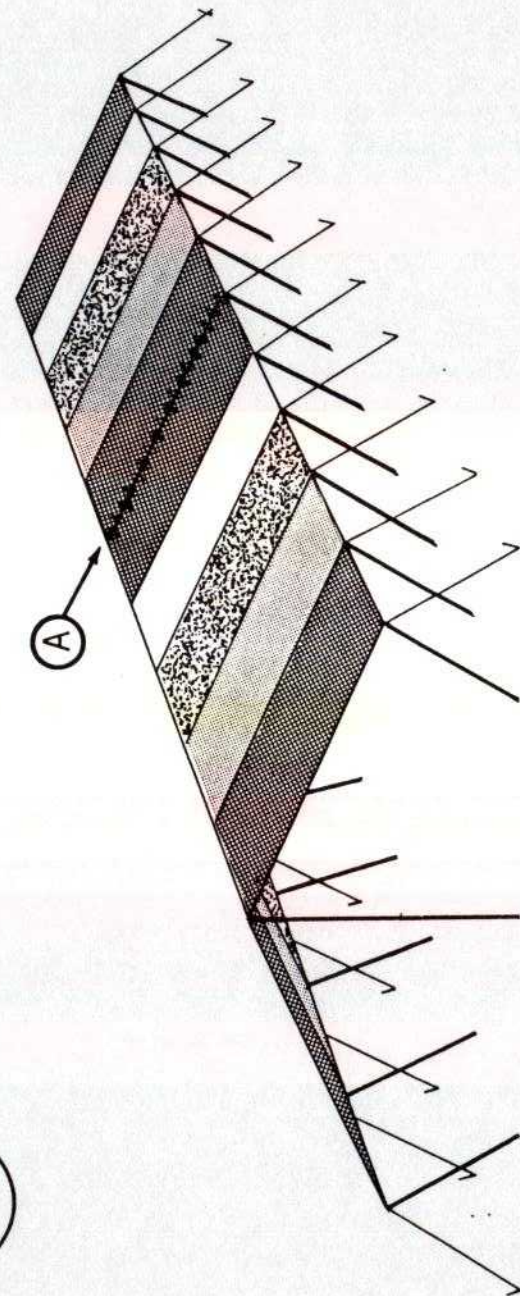
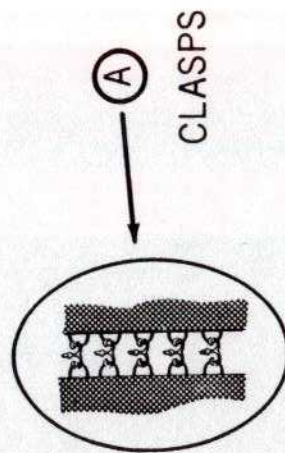
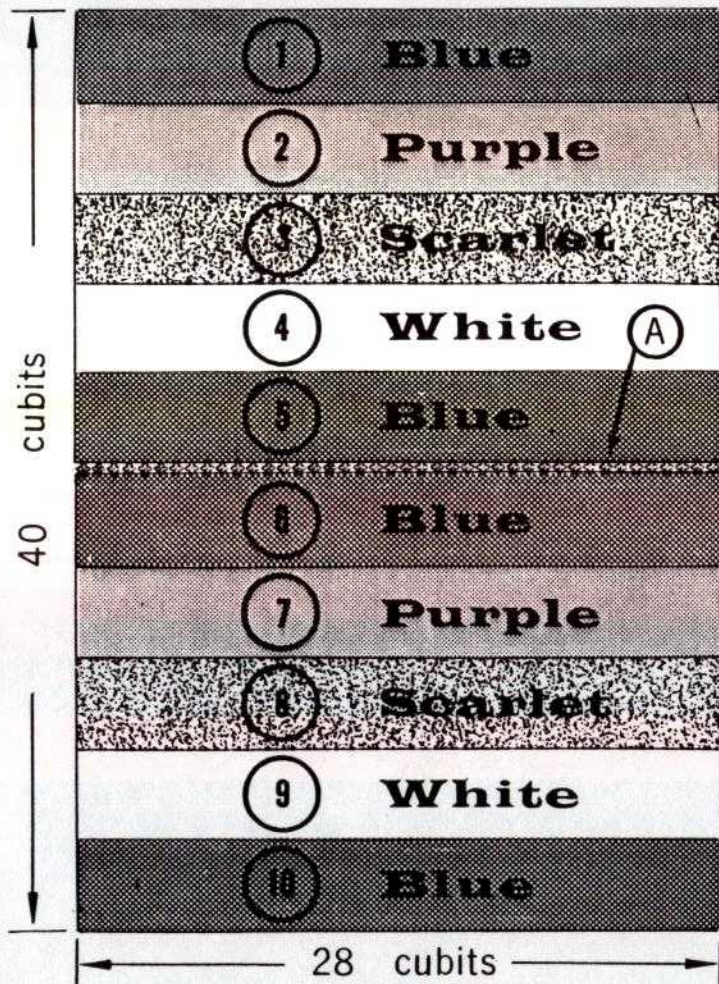

THE TABERNACLE

truction. The curtains are of only four colors; fine (white) twined linen, and blue, and purple, and scarlet; but there are five curtains in each of two sections as shown in the previous drawings. The arrangement of the colors cannot be certainly determined, but it would seem that the curtains at the center were blue. From the selvedge of these curtains blue loops were made with which to fasten the sections together. (Ex. 26:4) Each pair of the fifty pairs of loops was fastened together by gold taches or clasps. The embroidery was of cherubim. We cannot possibly reproduce these creatures so have made no attempt to do so. We are not told whether they were embroidered with gold or a color. No gold is specified in the Scripture for these curtains. Following the Divine order as given, we cannot put this, the Tabernacle, on the boards as is so often done; for the boards have not yet been given. We are at this point at a loss as to how it is to be erected, but the next curtains solve the problem.

"And thou shalt make curtains of goats' hair to be a covering upon the tabernacle." (Ex. 26:7) This verse should read, "And thou shalt make curtains of goats' hair to be a TENT OVER the tabernacle." The word TENT, determines somewhat the construction; for tents were known and used many years before the Tabernacle. Now, the drawing following will show the fit of the tent to the Tabernacle. It appears that the Tabernacle was a sort of lining to the tent.

7 ¶ And thou shalt make curtains of goats' hair to be a covering upon the tabernacle: eleven curtains shalt thou make.

8 The length of one curtain shall be thirty cubits, and the breadth of one curtain four cubits: and the eleven curtains shall be all of one measure.

Ex. 26:7, 8

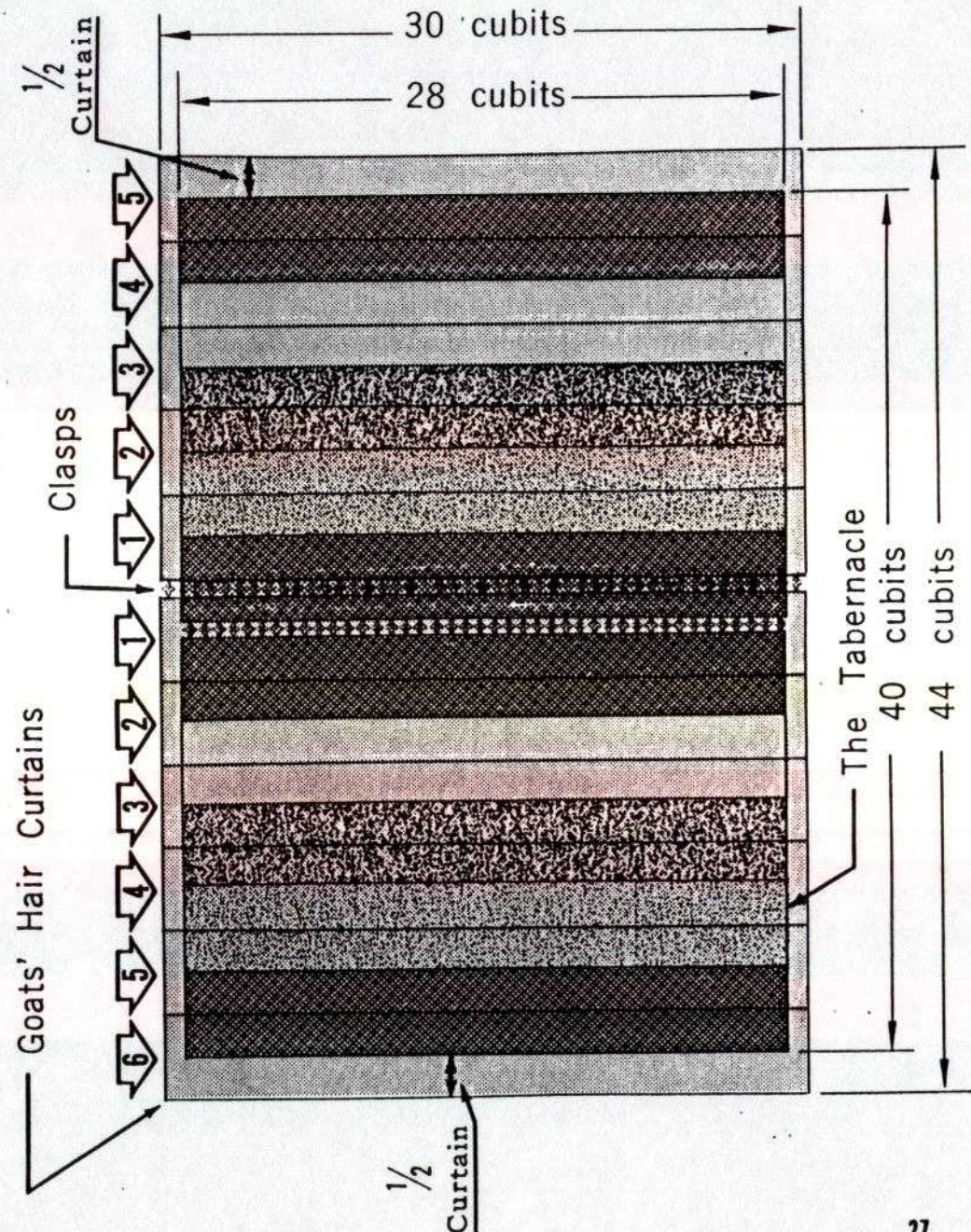

9 And thou shalt couple five curtains by themselves, and six curtains by themselves, and shalt double the sixth curtain in the forefront of the tabernacle.

10 And thou shalt make fifty loops on the edge of the one curtain *that is* outmost in the coupling, and fifty loops in the edge of the curtain which coupleth the second.

11 And thou shalt make fifty taches of brass, and put the taches into the loops, and couple the tent together, that it may be one.

12 And the remnant that remaineth of the curtains of the tent, the half curtain that remaineth, shall hang over the backside of the tabernacle.

13 And a cubit on the one side, and a cubit on the other side of that which remaineth in the length of the curtains of the tent, it shall hang over the sides of the tabernacle on this side and on that side, to cover it.

Ex. 26:9-13

The tent consisted of eleven curtains each 30 cubits long while the linen curtains were only 28 cubits long. Accordingly, 1 cubit of the tent extended over each side of the Tabernacle. The total length of the tent was 11 x 4 or 44 cubits while the Tabernacle was 10 x 4 or 40 cubits. Two cubits of the tent (one half of a curtain) was folded under in front (Ex. 26:9), thus the total length of the tent was reduced to 42 cubits. The forty-two cubits extends beyond the forty cubits of the Tabernacle by two cubits (one half a curtain) which hangs over the back. (Ex. 26:12)

For further proof that these coverings do not rest on the boards, let us assume that the board structure, which we shall soon consider, is the Tabernacle. The tent is 44 cubits long. Two cubits are folded in front leaving 42 cubits.

The boards are 30 cubits long. Thus, 42 less 30 leaves twelve cubits hanging over the back. One curtain is 4 cubits wide, so we see three whole curtains hanging over the back, whereas the Scripture says one half a curtain is all that is left to fall over the back. (Ex. 26:12)

The skin coverings are weather-proof coverings for the tent. The inside covering is of rams' skins dyed red and the outside skins (probably also rams' skins) dyed blue as we have explained. Not a single dimension is given for these weather-proof coverings. The outermost covering probably had some sections which reached to the ground as is alluded to in Josephus. Now that all four tent-shaped coverings are in place (their shape is determined by the tent), we proceed to the boards.

14 And thou shalt make a covering for the tent *of* rams' skins dyed red, and a covering above *of* badgers' skins.

Ex. 26:14

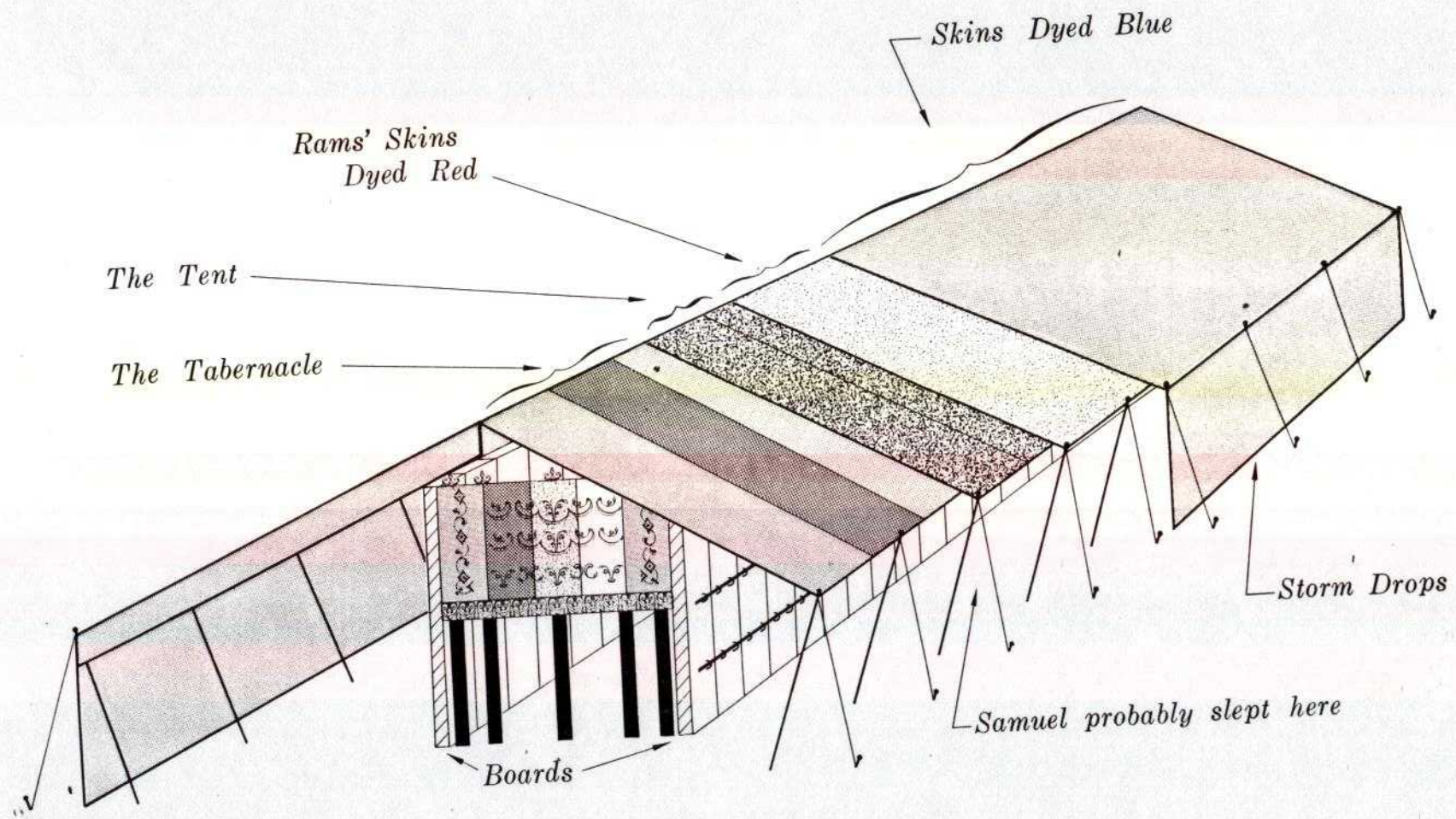

THE BOARDS FOR THE TABERNACLE

The preceding drawing shows a view of the boards as covered by the four coverings with part of each covering cut away so as to give a better view of the arrangement. The height and width of each board is given, but nothing is mentioned regarding the thickness. The thickness might be about nine inches but this is largely conjecture and cannot be proven. It is my opinion that all boards are exactly alike. (Ex. 26:16, 17).

Projecting from the bottom of each board were two tenons as shown in the following drawing. Each of these tenons fitted into a silver socket of 1 talent-weight, approximately 96 pounds. There was a total of 48 such boards, twenty on each side, six for the west end or as is more correct, "the two sides westward," and two corner boards. (Ex. 26:27) The board structure was stiffened at the two back corners by what are called "boards for the corners." (Ex. 26:23) These boards were locked into rings at the base and into still other rings above the top. (Ex. 26:24)

The boards were further held in position by bars which ran along the side. When assembled, there were five bars on each side as well as the end. In all probability these bars were not continuous lengths but assembled morticed and tenoned in short sections as others have shown. These bars passed through rings in the boards to support the boards. The rings were in all likelihood U-shaped, being driven into the boards.*

There is a common problem which should be considered at this point, that is concerning the middle bar, "And the middle bar in the midst of the boards shall reach from end to end." (Ex. 26:28) We read further in Ex. 36:33, "And he made the middle bar to shoot through the boards from the one end to the other." Does this mean that there was a bar

which passed from one end to the other through holes bored in the boards themselves?

15 ¶ And thou shalt make boards for the tabernacle of shittim wood standing up.

16 Ten cubits *shall be* the length of a board, and a cubit and a half *shall be* the breadth of one board.

17 Two tenons *shall there be* in one board, set in order one against another: thus shalt thou make for all the boards of the tabernacle.

18 And thou shalt make the boards for the tabernacle, twenty boards on the south side southward.

19 And thou shalt make forty sockets of silver under the twenty boards; two sockets under one board for his two tenons, and two sockets under another board for his two tenons.

Ex. 26:15-19

BOARDS

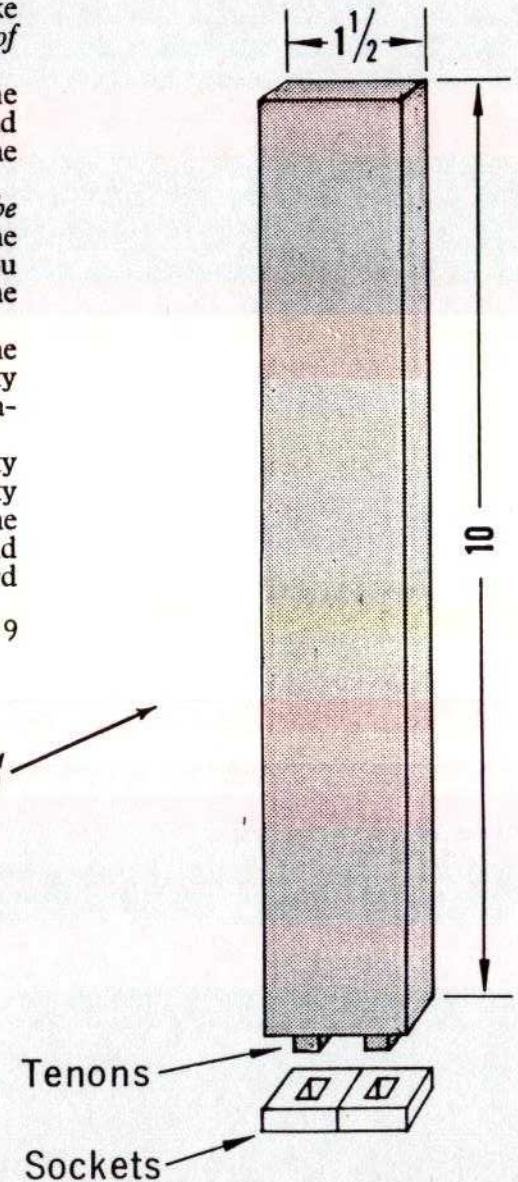

20 And for the second side of the tabernacle on the north side *there shall be twenty boards:*

21 And their forty sockets of silver; two sockets under one board, and two sockets under another board.

22 And for the sides of the tabernacle westward thou shalt make six boards.

23 And two boards shalt thou make for the corners of the tabernacle in the two sides.

24 And they shall be coupled together beneath, and they shall be coupled together above the head of it unto one ring: thus shall it be for them both; they shall be for the two corners.

25 And they shall be eight boards, and their sockets of silver, sixteen sockets; two sockets under one board, and two sockets under another board.

26 ¶ And thou shalt make bars of shittim wood; five for the boards of the one side of the tabernacle,

27 And five bars for the boards of the other side of the tabernacle, and five bars for the boards of the side of the tabernacle, for the two sides westward.

28 And the middle bar in the midst of the boards shall reach from end to end.

29 And thou shalt overlay the boards with gold, and make their rings of gold for places for the bars: and thou shalt overlay the bars with gold.

30 And thou shalt rear up the tabernacle according to the fashion thereof which was shewed thee in the mount.

Ex. 26:20-30

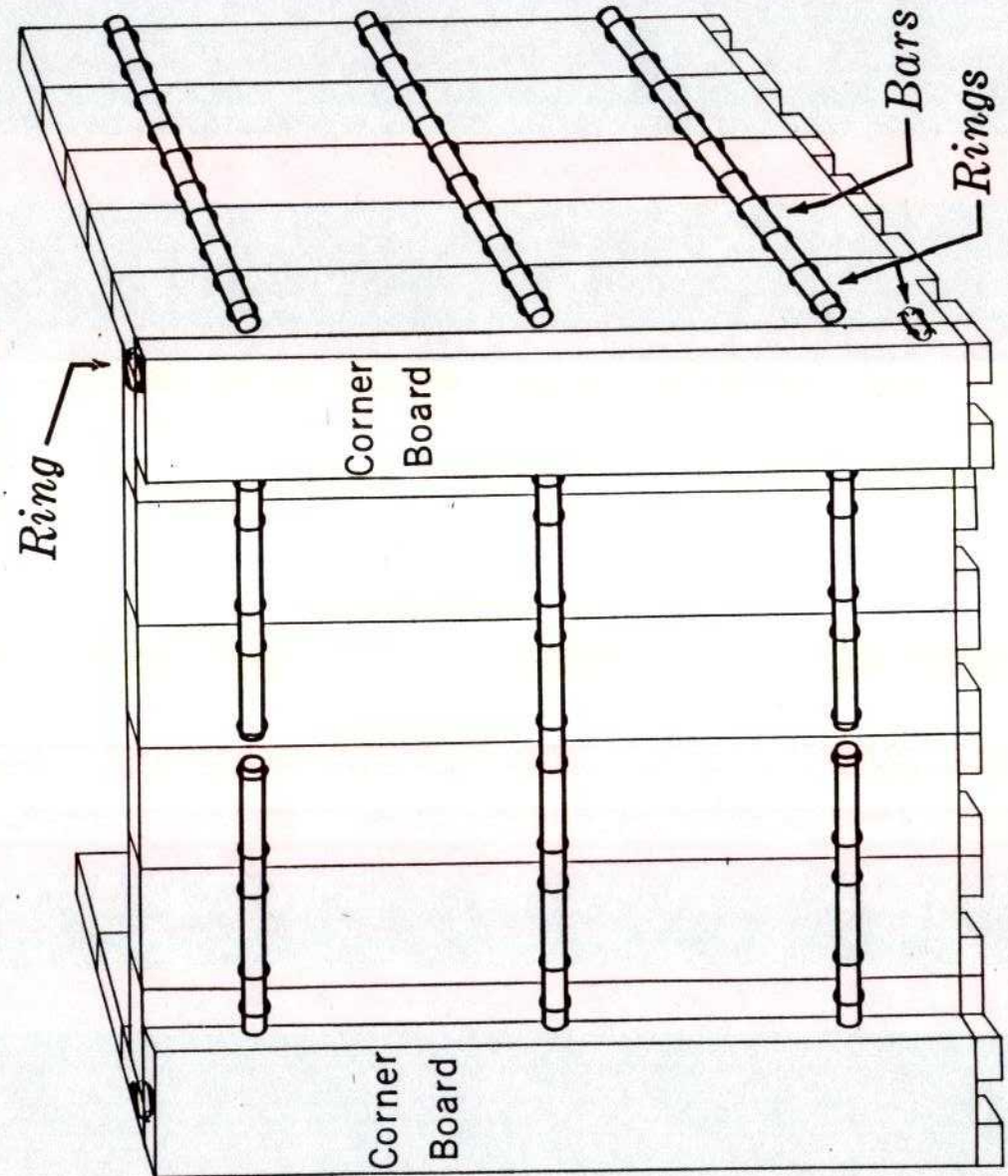
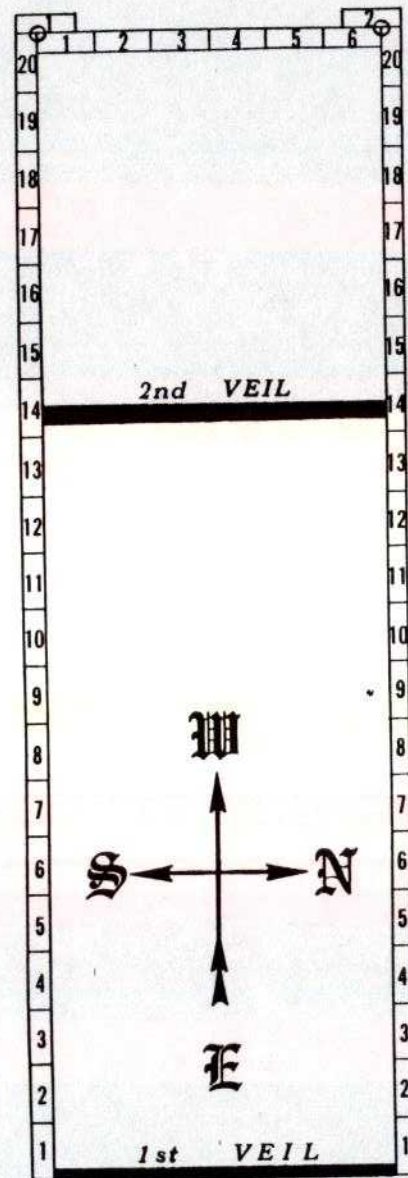

Let us assume a hole through a board. This hole would be 27" long, which itself presents no small task. Putting a wooden bar overlaid with a very thin covering of gold through this hole, presents further difficulties. First, the gold would be damaged seriously by rubbing against such a rough hole and even a small diameter bar in a large hole would necessarily rub. Second, if the bar were very slightly bent, it would not start through the next board. Third, the holes in the boards could not be put in close alignment on such a rough foundation as the ground itself. Imagine now trying to put a pole 45 feet long, if such could be found, through a hole the same length.

It is my opinion, from an engineering standpoint, that the American Standard Version translation is to be preferred. "And he made the middle bar to pass through (the rings) in the midst (half way up) of the boards from the one end to the other." (Ex. 36:33) This is the way it is shown in the drawings.

Other than the weight, nothing is known concerning the sockets. It is the weight of 1 talent which is of importance and this stands out as our only information.

The gold overlay on the boards can, at best, only be estimated as to thickness. We are given the total gold used in the structure. A close approximation for this thickness would be .010" or the thickness of a 3¢ postcard.

THE TWO VEILS

There is one outstanding fact given in regards to the veil. It was to divide the holy place from the holy of holies. (Ex. 26:33) Men could enter the holy place. God dwelt in the holy of holies and only through the One Mediator, could man meet God. ". through the veil, that is to say, his flesh." (Hebrews 10:20) The veil was supported on 4 pillars overlaid with gold, each resting on its own silver socket. Whether or not there was a lintel, as shown in the drawing following, is not definitely known. The veil was identical to the 10-curtain Tabernacle as far as the colors and subject (cherubim) of the embroidery is concerned.

Often a question is raised as to the thickness of this veil. As far as we know in the day of the Tabernacle, it was very thin. Some have compared their linen to our finest of silk. The veil which was rent at the time of the death of the Lord Jesus, however, was not the Tabernacle veil but the one in Herod's temple. (Matt. 27:51) This veil was said to have been several inches thick.

31 ¶ And thou shalt make a veil of blue, and purple, and scarlet, and fine twined linen of cunning work: with chër'-û-bîms shall it be made:

32 And thou shalt hang it upon four pillars of shittim wood overlaid with gold: their hooks shall be of gold, upon the four sockets of silver.

Ex. 26:31, 32

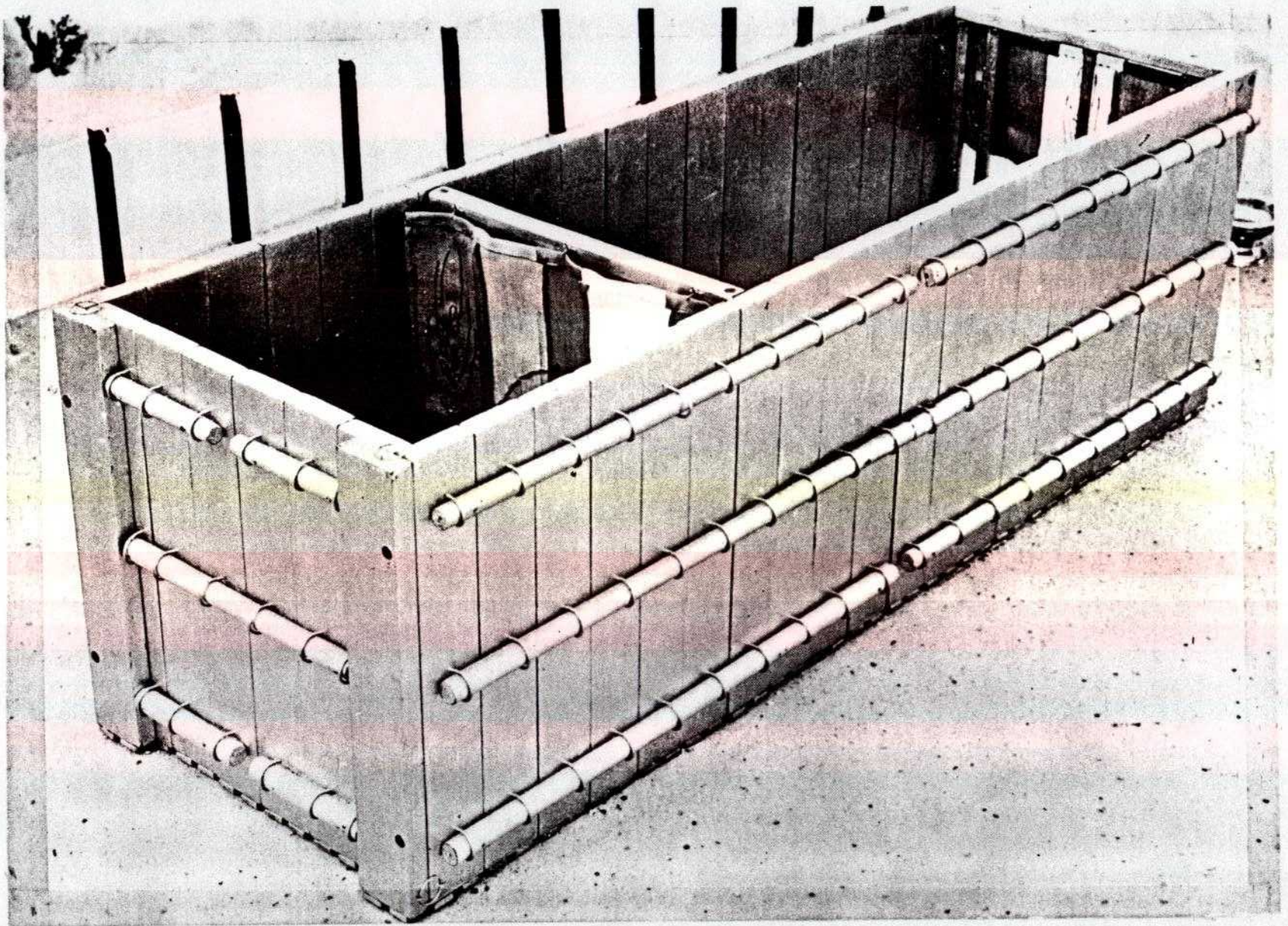

It might be of interest to note that the height of the board structure is given as 10 cubits. The total length can be figured, 20 boards each 1 1/2 cubits wide, or 30 cubits. There is, however, no record of the length of the holy place, or the holy of holies. This is striking and important, for the entire structure had to be moved. Except on the day of atonement, no one could ever enter the holy of holies, neither were the people permitted to see the ark of the covenant. How could the ark be moved; first, without anyone seeing it and; second, without anyone going into the holy of holies to get it? The first part was easy. The veil was used as a cover for the ark. The priests lowering the veil and yet keeping it above their heads, could walk forward without seeing the ark and cover it. (Num. 4:5) But were they not going into the holy of holies? The answer is definitely, No. The veil, not the pillars, separated the holy place from the holy of holies, and as the veil was moved forward, the holy of holies became smaller and the holy place larger. Now, you see why no length dimensions are given for the holy of holies; it was variable. With the veil around the ark, the holy of holies was, in effect, the ark itself.

33 ¶ And thou shalt hang up the veil under the taches, that thou mayest bring in thither within the veil the ark of the testimony: and the veil shall divide unto you between the holy place and the most holy.

34 And thou shalt put the mercy seat upon the ark of the testimony in the most holy place.

35 And thou shalt set the table without the veil, and the candlestick over against the table on the side of the tabernacle toward the south: and thou shalt put the table on the north side.

Ex. 26:33-35

THE VEIL, that is to say HIS FLESH

Hebrews 10:20

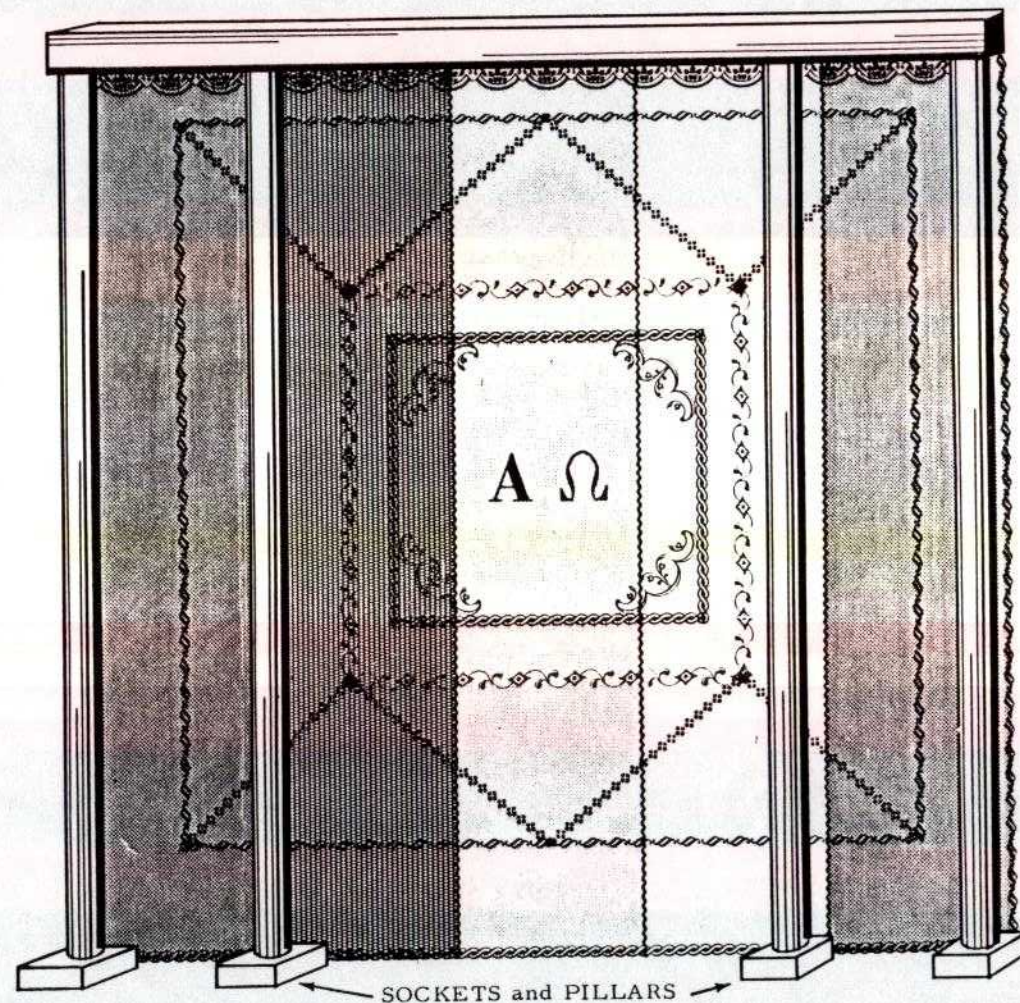

I am Alpha (Α) and Omega (Ω), the beginning and the end, the first and the last. (Revelation 22:13)

COVERINGS:

- ① The Tabernacle
- ② The Tent
- ③ Rams' Skins Dyed Red
- ④ Blue Skins

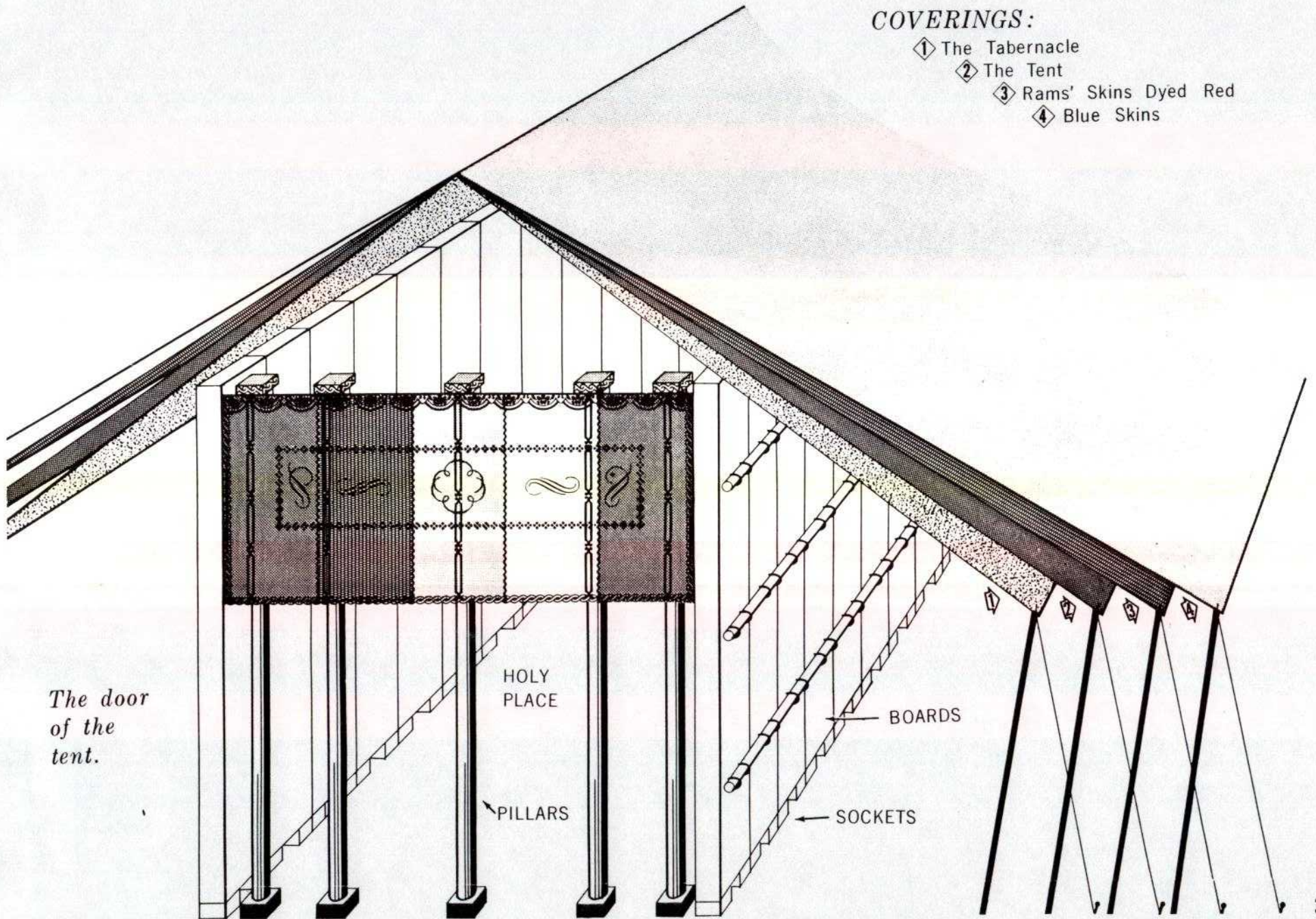

The door of the tent.

HOLY PLACE

PILLARS

BOARDS

SOCKETS

The entrance to the holy place was very similar to the veil we have just described, except that embroidered cherubim are not specified. It was supported on 5 pillars instead of 4 and each of the pillars was stood on, not silver, but brass sockets. These pillars had a crown on the top. (Ex. 36:38) These, too, were overlaid with gold.

There is no reason to believe that this veil was always kept closed, quite to the contrary. Josephus explains that the view into the sanctuary was not to be impaired. He further explains that it was drawn half way up by gold rings. (Josephus - ANTIQUITIES, chapter 6)

36 And thou shalt make an hanging for the door of the tent, of blue, and purple, and scarlet, and fine twined linen, wrought with needlework.

37 And thou shalt make for the hanging five pillars of shittim wood, and overlay them with gold, and their hooks shall be of gold: and thou shalt cast five sockets of brass for them.

Ex. 26:36, 37

38 And the five pillars of it with their hooks: and he overlaid their chapiters and their fillets with gold: but their five sockets were of brass.

Ex. 36:38

THE COMPLETED STRUCTURE

Completely around the outside was a sort of fence called the "hangings for the court." The hangings were of fine-twined linen which we have previously shown were white. The one exception was the gate which was embroidered and of the same colors as the veils. These hangings were 50 cubits by 100 cubits and 5 cubits high, or approximately 75 feet by 150 feet and 7 1/2 feet high. Sixty pillars supported the hangings and gate. Many experience some difficulty in the arrangement of these pillars and we have endeavored to explain the arrangement in the following drawing. The material of the pillars is not given; that they were not brass may be seen from the text. (Ex. 38:29-31) It is generally assumed that they were of shittim wood. Each pillar stood on a brass socket. The capital of the pillar was overlaid with silver. The hooks and fillets which supported the linen hangings were also of silver. Dr. Strong many years ago pointed out that the word for hooks was written in very ancient times by a cross, and we have followed his suggestion in this matter. The fillets have long been a point of question, but it does seem that this was some sort of silver wire which ran from post to post to give sidewise stability while the cords and brass pins furnished anchorage as well as stability.

9 ¶ And thou shalt make the court of the tabernacle: for the south side southward there shall be hangings for the court of fine twined linen of an hundred cubits long for one side:

10 And the twenty pillars thereof and their twenty sockets shall be of brass; the hooks of the pillars and their fillets shall be of silver.

Ex. 27:9, 10

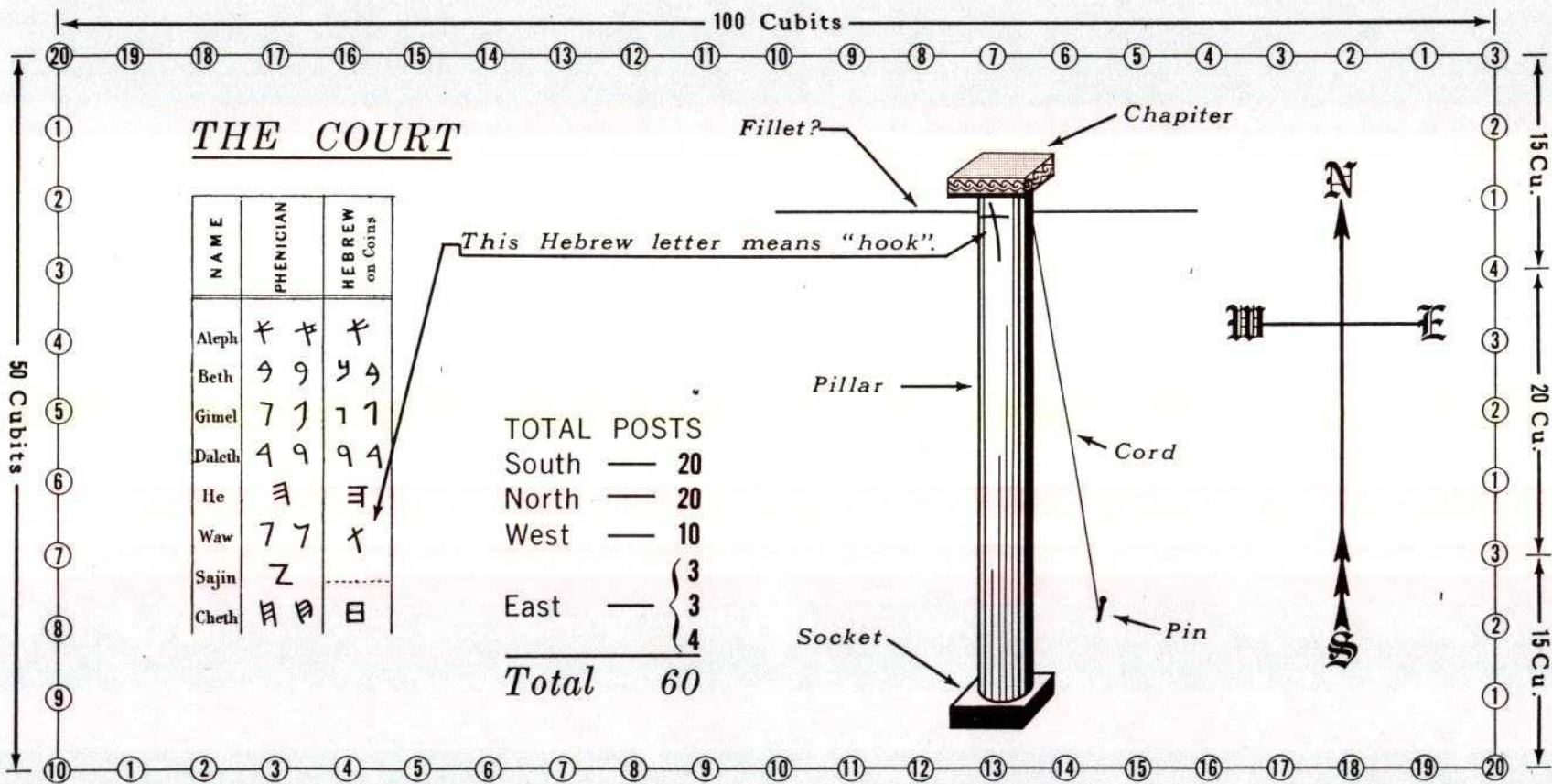

11 And likewise for the north side in length *there shall be* hangings of an hundred cubits long, and his twenty pillars and their twenty sockets of brass; the hooks of the pillars and their fillets of silver.

12 ¶ And for the breadth of the court on the west side *shall be* hangings of fifty cubits: their pillars ten, and their sockets ten.

13 And the breadth of the court on the east side eastward *shall be* fifty cubits.

14 The hangings of one side of the gate *shall be* fifteen cubits: their pillars three, and their sockets three.

15 And on the other side *shall be* hangings fifteen cubits: their pillars three, and their sockets three.

16 ¶ And for the gate of the court *shall be* an hanging of twenty cubits, of blue, and purple, and scarlet, and fine twined linen, wrought with needlework: and their pillars *shall be* four, and their sockets four.

17 All the pillars round about the court *shall be* filleted with silver; their hooks *shall be* of silver, and their sockets of brass.

18 ¶ The length of the court *shall be* an hundred cubits, and the breadth fifty every where, and the height five cubits of fine twined linen, and their sockets of brass.

19 All the vessels of the tabernacle in all the service thereof, and all the pins thereof, and all the pins of the court, *shall be* of brass.

Ex. 27:11-19

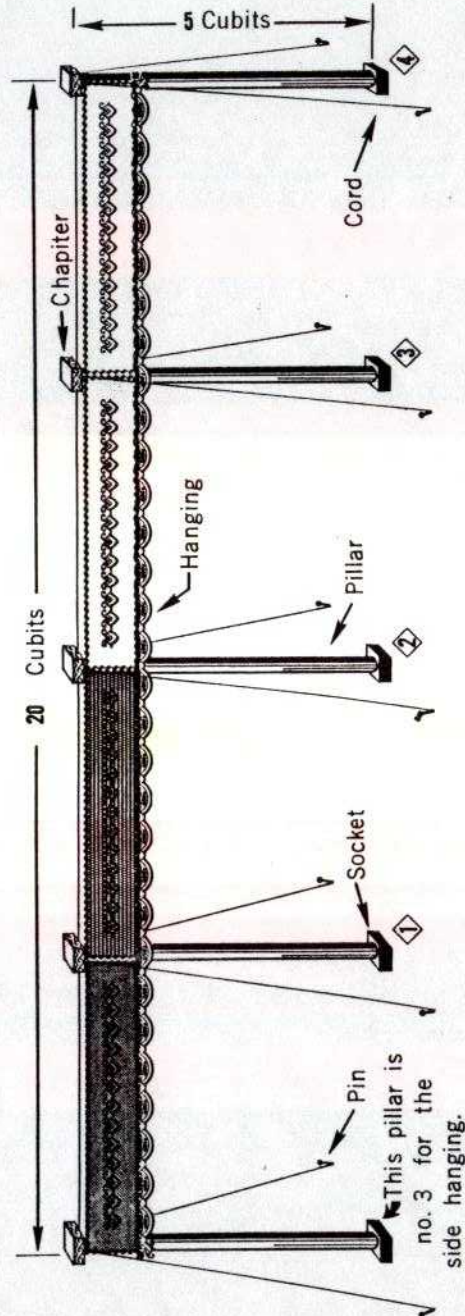

We have now completed a brief description of God's Tabernacle in Israel's wilderness journey. The structure with its furniture was not only beautiful but extremely practical. The sky-blue skins which formed the outer covering would reflect the heat. The quadruple covering provided three dead-air spaces which formed excellent insulation both against the heat of the day and against the cool of the night.

The pitch of the coverings provided protection from rain and snow. The height of the boards, 15 feet, provided a convection arrangement to aid removal of stale air and smoke. The triangular openings at each end allowed escape of hot air and smoke while also allowing some light. The way the coverings were extended beyond the boards provided living quarters for the priests, and here it was that Samuel grew up, for the permanent type structure built by Solomon did not yet exist. (1 Sam. 3) Here also the priests could bathe and prepare for their part in the services. This entire structure could be quickly dissembled and moved from place to place. It was not large, not nearly large enough for the people to assemble, for at best only approximately 1,000 persons could be in the court at any one time, yet here were approximately 2,500,000 people. Quite obviously this was not a building to be used as we use a church. It was used as we use our Bible, for this was God's picture book of the entire plan of salvation.

For many years an erroneous structure has been taught which shows the coverings all resting on the 48 boards. For the student, we now compare this construction with the one we have described throughout this text.

THE COVERINGS

ON THE BOARDS

(as erroneously taught)

1. does not follow the scriptural text

2. has no ventilation

ON A RIDGE

(as shown in the text)

1. adheres to the text

2. good ventilation

“Open thou mine eyes,
that I may behold wondrous
things out of thy law.”

Psalms 119:18

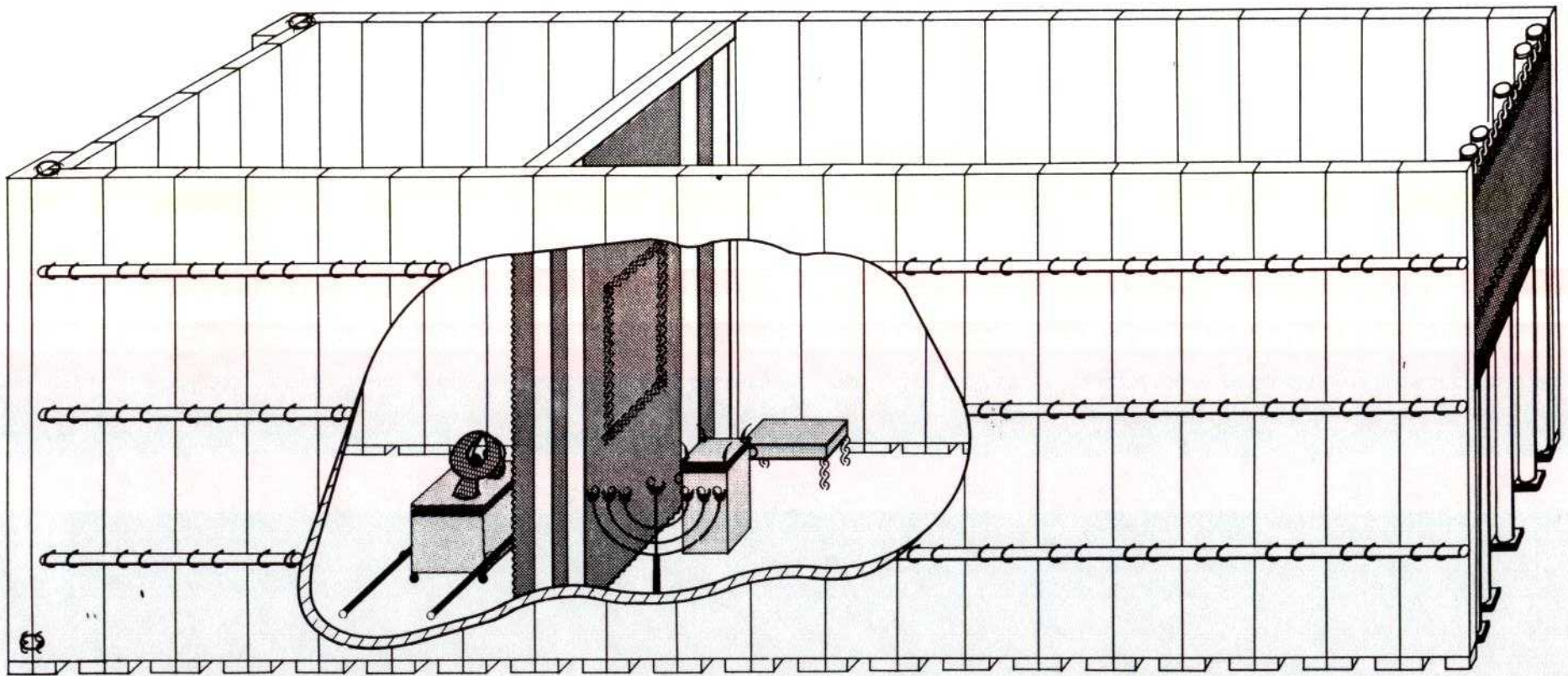

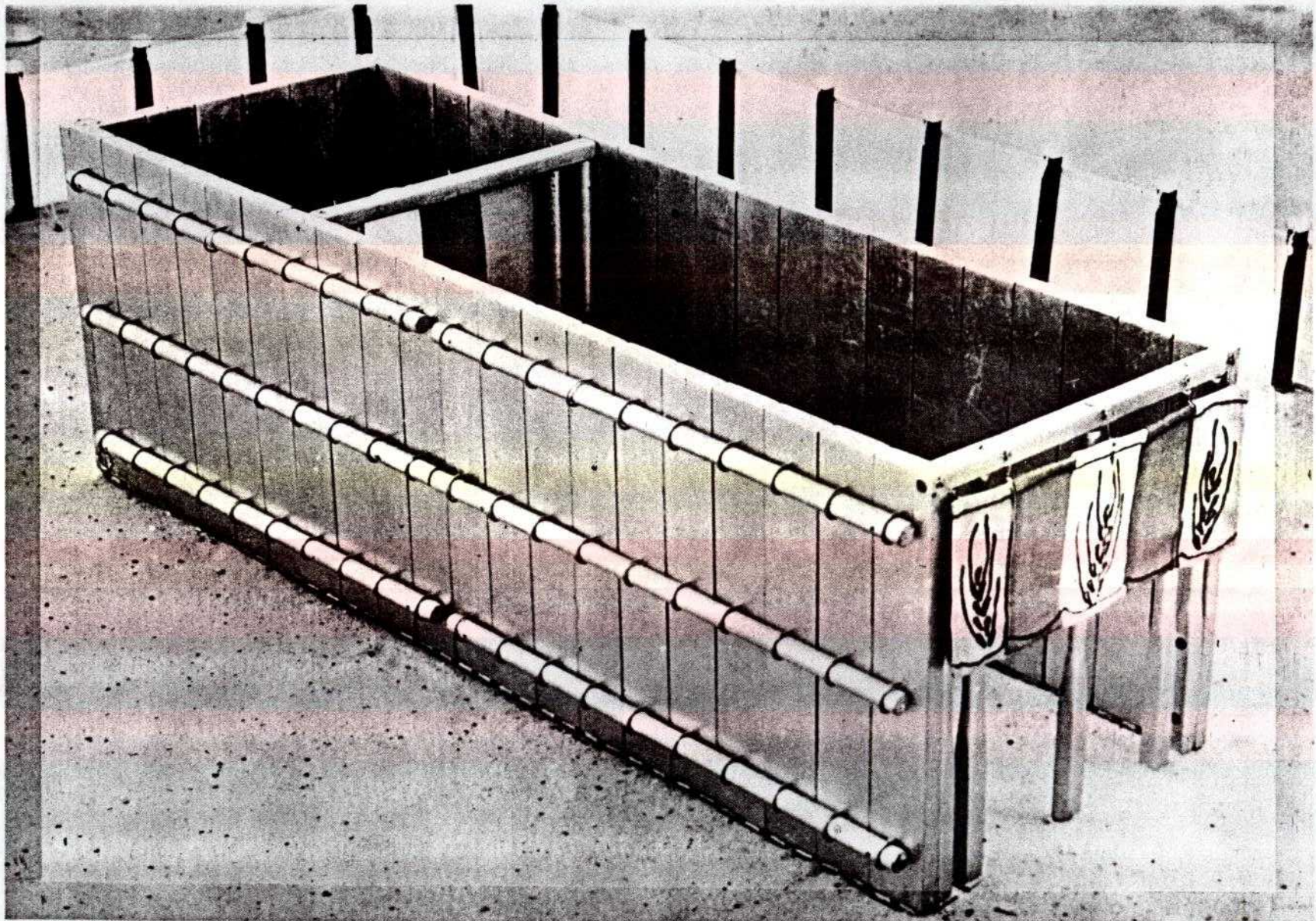

3. no arrangement to allow escape of smoke from lamps and incense
4. would collapse in the rain or snow
5. no possible place for priests to bathe
6. no quarters for Samuel and priests
7. almost impossible to assemble without damage to coverings
8. coverings lie in piles on the ground behind the building
9. the sequence given by God provides boards only after the coverings are finished
10. the symbolism: boards, the believers, support Christ the Tabernacle--WRONG

3. ample escape provided for smoke
4. would shed water as any tent
5. dressing rooms provided in the overhang
6. adequate quarters for Samuel and priests
7. coverings erected as a tent then board structure assembled underneath
8. no coverings touch the ground
9. the sequence given by God provides boards only after the coverings are finished
10. the symbolism: the Tabernacle, Christ crucified provides shelter for the believers, the boards--RIGHT

The Tabernacle of Witness was in the midst of the camp of Israel. Moving was the job of more than 8500 Levites. Certainly the man-power was sufficient to dismantle the structure and be on the way in less than one half hour. Nearly everything was carried on their shoulders. Six small carts were allotted for miscellaneous materials: pins, cords, etc. We are told how the furniture was carried and I believe the boards and posts were put on large leather stretchers and carried on their shoulders. (Num. 4) Quite obviously the boards were not placed on the carts. Damage to the boards would be extensive and a single ox team could pull but very little weight over such rough terrain.

For many years the Tabernacle of Witness served Israel as a meeting place with God. Then, as far as scripture is concerned, it seems to have disappeared. The skeptics go so far as to say it never existed, and no wonder, it is an amazing proof of the truth of God's Word. Are the scriptures as silent as it first appears? I think not. Read carefully Ezekiel 37. "---Thus saith the Lord God; Behold, I will take the children of Israel from among the nations, whither they be gone, and will gather them on every side, and bring them into their own land:---Moreover I will make a covenant of peace with them; it shall be an everlasting covenant with them:---and will set my sanctuary in the midst of them for evermore. My tabernacle also shall be with them: yea, I will be their God, and they shall be my people." (Ezekiel 37:21, 26, 27)

Some will say that this doesn't refer to the Tabernacle Israel had in the Wilderness; it just means God will "dwell" with Israel. Turn to Leviticus, chapter 26 and read further. "If ye walk in my statutes, and keep my commandments, and do them;...I will have respect unto you,...and establish my covenant with you...And I will set my tabernacle among you." Moses had the Tabernacle in the Wilderness and never used the word "Tabernacle" when referring to God's dwelling, other than to the real structure itself, yet Moses records that God said, "I WILL SET MY TABERNACLE AMONG YOU." (Lev. 26:3, 9, 11)

Is there any historic clue as to the whereabouts of this original structure? I believe that the second book of Machabees gives some worthwhile information. "It was also contained in the same writing, how the prophet, being warned by God, commanded that the tabernacle and the ark should accompany him, till he came forth to the mountain where Moses went up, and saw the inheritance of God. And when Jeremias came thither he found a hollow cave; and he carried in thither the tabernacle, and the ark, and the altar of incense, and so stopped the door. Then some of them that followed him, came up to mark the place: but they could not

find it. And when Jeremias perceived it, he blamed them, saying: The place shall be unknown, TILL God gather together the congregation of the people, and receive them to mercy. And then the Lord will shew these things, and the majesty of the Lord shall appear, and there shall be a cloud as it was also shewed to Moses." (2 Mach. 2:4-8, Confraternity Edition) Moses saw God's land from Mt. Nebo. (Deut. 34:1-4) Some question the historic value of Maccabees. With two references to a future for the Tabernacle and no historic record of its destruction, I choose to accept the evidence we have, and believe the Tabernacle will some day be found in the region of Mt. Nebo.

In another apocryphal book, Tobias, chapter 13, verse 11 the Septuagint records, "in order that he might again rebuild his Tabernacle."

Could it be that God would restore the Tabernacle to Israel in our day? The second book of Maccabees says it will be, when God re-gathers Israel. May 14-15, 1948, the people of Israel became a nation once again. "Who hath heard such a thing? who hath seen such things? Shall a land be born in one day? shall a nation be brought forth at once?" (Isaiah 66:8 ASV) And today the flag of Israel flies over God's land. "Thou hast given a banner (flag) to them that fear thee, that it may be displayed BECAUSE OF THE TRUTH." (Ps.60:4) The Tabernacle is the most important structure ever built by man.



The Flag
of Israel

As we have intimated, from time to time in this short work the principal purpose in the Tabernacle is to point to Jesus Christ our Lord and Saviour. This field itself has three divisions which we have arbitrarily termed: SHADOWS, INTERPRETATIONS, and APPLICATIONS.

I prefer to define a "shadow" as something Israel saw pointing to the Messiah as they waited for Him. An "Interpretation", I take to be a part of the law as it is explained by the Holy Spirit in some other portion of the scripture. An "application" is an illustration for our daily life taken from this source, this particular phase we leave to every believer as its basis is not directly scriptural.

I believe personally that those Old Testament Saints who were spiritually-minded knew and understood the coming and suffering and death of the Messiah. I believe that any person having the Law could by the Holy Spirit see the entire plan of salvation. The "scriptures" as referred to in the New Testament, is the Old Testament. No New Testament was yet written.

1. "And beginning at Moses and all the prophets, he expounded unto them in all the scriptures the things concerning himself." (Luke 24:27)

2. "Did not our heart burn within us, while he talked with us by the way, and while he opened to us the scriptures?" (Luke 24:32)

3. "And he said unto them, These are the words which I spake unto you, while I was yet with you, that all things must be fulfilled, which were written in the law of Moses, and in the prophets, and in the Psalms, concerning me. Then opened he their understanding, that they might understand the scriptures, And said unto them, Thus it is written, and thus it behoved Christ to suffer, and to rise from the dead the third day." (Luke 24:44-46)

4. "For had ye believed Moses, ye would have believed me: for he wrote of me. But if ye believe not his writings, how shall ye believe my words?" (John 5:46,47)

5. "Search the scriptures; for in them ye think ye have eternal life: and they are they which testify of me."
(John 5:39)

6. "And Paul, as his manner was, went in unto them, and three sabbath days reasoned with them out of the scriptures, Opening and alleging, that Christ must needs have suffered, and risen again from the dead; and that this Jesus, whom I preach unto you, is Christ." (Acts 17:2, 3)

7. "For he mightily convinced the Jews, and that publicly, shewing by the scriptures that Jesus was Christ." (Acts 18:28)

8. "For I delivered unto you first of all that which I also received, how that Christ died for our sins according to the scriptures; And that he was buried, and that he rose again the third day according to the scriptures." (1 Cor. 15:3, 4)

This is ample evidence that the Old Testament pointed to the coming and death and resurrection of Israel's Messiah. But the question comes, Did they themselves know? Abraham knew. "...Abraham rejoiced to see my day: and he saw it, and was glad." (John 8:56) David knew. "Therefore being a prophet, and knowing that God had sworn with an oath to him, that of the fruit of his loins, according to the flesh, he would raise up Christ to sit on his throne: He seeing this before spake of the resurrection of Christ, that his soul was not left in hell, neither his flesh did see corruption." (Acts 2:30-31) Moses knew. "Esteeming the reproach of Christ greater riches than the treasures in Egypt: for he had respect unto the recompence of the reward." (Hebrews 11:26) Could they know without the written word? I believe the pictures of the Law made the plan of salvation clear to those spiritually enlightened.

A HEAVENLY PATTERN

Many spiritual truths which seem so plain and clear to an older Christian and thrill the hearts of new Christians, seem as foolishness to the Unbeliever. The explanation for this phenomenon is given in the scripture.

14 But the natural man receiveth not the things of the Spirit of God: for they are foolishness unto him: neither can he know them, because they are spiritually discerned.
1 Cor. 2:14

Christ
our
passover

7 Purge out therefore the old leaven, that ye may be a new lump, as ye are unleavened. For even Christ our passover is sacrificed for us:

1 Cor. 5:7

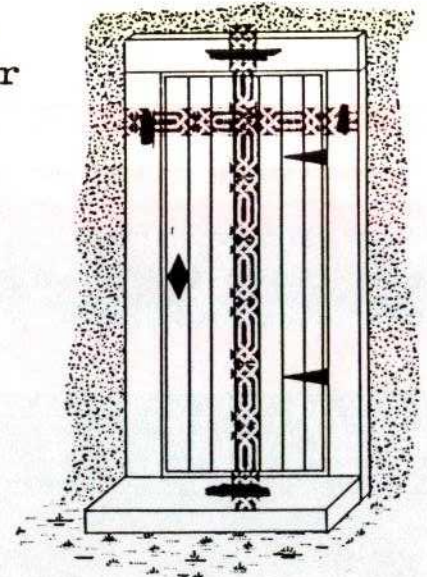

Spiritual truths lie hidden all through the Word of God. The Bible abounds in what we call types or shadows. Perhaps an illustration will help. When the nation of Israel came out of the land of Egypt, they killed the passover lamb as we have already explained. The blood was put in a basin and sprinkled on the door posts and lintel. This first passover was a type or shadow of the second passover, the Lord Jesus Christ. As you can see the Bible itself interprets the first passover lamb, explaining its fulfilment in the Lord Jesus. To make it even more clear, Jesus is called the Lamb of God.

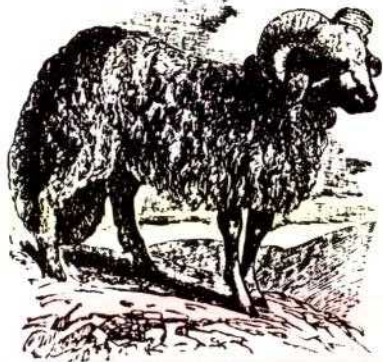

**Behold the Lamb - -
a bone of him shall
not be broken.**

The lifting up of the serpent in the wilderness was a type or shadow of the crucifixion of Christ as Jesus Himself explained. How was a serpent a picture of Jesus? The serpent is clearly a picture of sin and Jesus Christ became sin for us as the scriptures record.

29 ¶ The next day John seeth Jesus coming unto him, and saith, Behold the Lamb of God, which taketh away the sin of the world.

John 1:29

36 For these things were done, that the scripture should be fulfilled, A bone of him shall not be broken.

John 19:36

As Moses lifted up the serpent

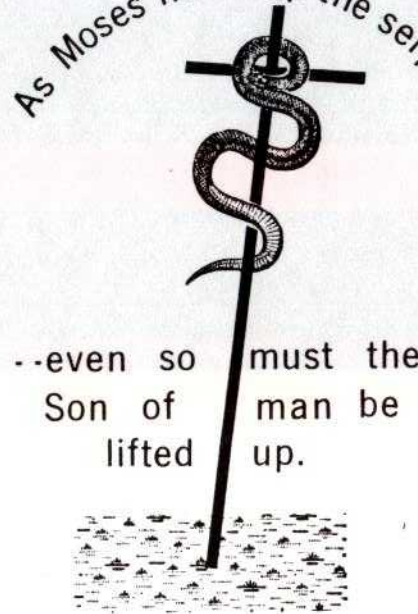

- even so must the
Son of man be
lifted up.

14 ¶ And as Moses lifted up the serpent in the wilderness, even so must the Son of man be lifted up:

15 That whosoever believeth in him should not perish, but have eternal life.

16 ¶ For God so loved the world, that he gave his only begotten Son, that whosoever believeth in him should not perish, but have everlasting life.

John 3:14-16

21 For he hath made him *to be* sin for us, who knew no sin; that we might be made the righteousness of God in him.

2 Cor. 5:21

While there are many such types and shadows, the most outstanding of them all is God's Tabernacle in Israel's wilderness journey or as it is sometimes called the Tabernacle of Witness.

The Tabernacle of Witness, (σκηνή τοῦ μαρτυρίου) Acts 7:44, which Israel had in the wilderness may well be translated, The Tabernacle of Proof. While the word tabernacle means, dwelling, and it was indeed God's dwelling in the midst of His people; the word also means, STAGE.

In effect, Israel had a great STAGE in which the High Priest daily enacted a great drama in a setting of Divine Proof of the Word of God.

Of all of the books in the Bible, the one most often used in leading a soul to Jesus is, of course, the gospel of John. In a sense this was the same purpose of the law in the Old Testament. Now it must be remembered, the law is always

the first five books of the Bible: Genesis, Exodus, Leviticus, Numbers, and Deuteronomy. The ten commandments are never called the law. The gospel of John contains a great deal of scripture directly from the law. Approximately one half of the law deals with the Tabernacle which fact alone makes this study of greatest importance.

While there are many types and shadows, the Tabernacle with its related services and history is emphasized in scripture more than all others combined. The Tabernacle is called a parable.

→
(παράβολή)
parabolā

9 Which *was* a figure for the time then present, in which were offered both gifts and sacrifices, that could not make him that did the service perfect, as pertaining to the conscience;

Heb. 9:9

Did you ever wonder why Jesus used so many parables? Even His disciples said, "Why speakest thou unto them in parables?" Matt. 13:10 Then, Jesus explained, "Unto you it is given to know the mysteries of the kingdom of heaven, but to them it is NOT given. For whosoever hath, to him shall be given, and he shall have abundance: but whosoever hath not, from him shall be taken away even that which he hath. Therefore speak I to them in parables; because seeing they see NOT, and hearing they hear NOT, neither do they understand." Matt. 13:11-13 A.S.V.

Perhaps, the following illustration will help you to understand. We have models of the Wilderness Tabernacle which we use in Bible Conferences. These models are very delicate and took a long time to build. We always caution our audience, and ask them not to touch the models. During one conference, a young lady would come to the front after each service and proceed to carefully handle all of the parts she could reach. One night as she tried to pick up the Golden Altar and found it to be just out of her reach, she stood upright and exclaimed, "Isn't it beautiful?" But I didn't tell

you--this young lady was totally blind; yet she could see through spiritual eyes, the beauties of those things which pointed to her Lord.

We find this explained further in 1 Cor. 2:9,10. "Eye hath not seen, nor ear heard, neither have entered into the heart of MAN, the things which God hath prepared for them that love him. But God HATH revealed them unto US by his Spirit: for the Spirit searcheth ALL things, yea, the DEEP things of God."

Not only is the Tabernacle a type, shadow, and parable but it is an earthly duplicate of what Moses and John saw in the heavens.

That there is a real Heavenly Tabernacle pitched in Heaven is the clear teaching of the Word of God. Moses was told to make everything, "according to all that I SHOW thee, after the pattern of the tabernacle." Ex. 25:9. And again, "And thou shalt rear up the tabernacle according to the fashion thereof which was SHOWED thee in the mount." Ex. 26:30. That Moses saw the Heavenly Tabernacle cannot be doubted, for we read in Acts 7:44; "Our fathers had the tabernacle of witness in the wilderness, as he had appointed, speaking unto Moses, that he should make it according to the fashion that he had SEEN."

9 According to all that I shew thee, *after* the pattern of the tabernacle, and the pattern of all the instruments thereof, even so shall ye make it.

Ex. 25:9

8 Hollow with boards shalt thou make it: as it was shewed thee in the mount, so shall they make it.

Ex. 27:8

40 And look that thou make *them* *after* their pattern, which was shewed thee in the mount.

Ex. 25:40

30 And thou shalt rear up the tabernacle according to the fashion thereof which was shewed thee in the mount.

Ex. 26:30

4 And this work of the candlestick *was* of beaten gold, unto the shaft thereof, unto the flowers thereof, *was* beaten work: according unto the pattern which the LORD had shewed Moses, so he made the candlestick.

Nu. 8:4

44 Our fathers had the tabernacle of witness in the wilderness, as he had appointed, speaking unto Moses, that he should make it according to the fashion that he had seen.

Acts 7:44

John the apostle, too, saw the Heavenly Tabernacle, for he wrote, "I saw seven golden candlesticks." Rev. 1:12. And again he wrote, "And the temple of God was opened in heaven, and there was seen in his temple the ARK of his testament." Rev. 11:19. "I looked, and behold, the temple of the tabernacle of the testimony in heaven was opened." Rev. 15:5.

12 And I turned to see the voice that spake with me. And being turned, I saw seven golden candlesticks;

Rev. 1:12

9 And when he had opened the fifth seal, I saw under the altar the souls of them that were slain for the word of God, and for the testimony which they held:

Rev. 6:9

19 And the temple of God was opened in heaven, and there was seen in his temple the ark of his testament: and there were lightnings, and voices, and thunders, and an earthquake, and great hail.

Rev. 11:19

5 And after that I looked, and, behold, the temple of the tabernacle of the testimony in heaven was opened:

Rev. 15:5

We may still call a third witness, the apostle Paul, who writes that Jesus is, "A minister of the sanctuary, and of the TRUE TABERNACLE, which the Lord PITCHED, and not man." Heb. 8:2. He also tells us, "THE HEAVENLY THINGS THEMSELVES" require better sacrifices than the earthly reproduction. Heb. 9:23.

The existence of a real heavenly tabernacle is without question. The question may well be asked, "Just how close a duplicate was the earthly of the heavenly?" The Holy Spirit

has spared no effort to make us understand that it is an exact copy but limited to earthly dimensions. Five different Greek words are used to impress this fact.

NOW of the things which we have spoken *this is* the sum: We have such an high priest, who is set on the right hand of the throne of the Majesty in the heavens;

2 A minister of the sanctuary, and of the true tabernacle, which the Lord pitched, and not man.

3 For every high priest is ordained to offer gifts and sacrifices: wherefore *it is* of necessity that this man have somewhat also to offer.

4 For if he were on earth, he should not be a priest, seeing that there are priests that offer gifts according to the law:

5 Who serve unto the example and shadow of heavenly things, as Moses was admonished of God when he was about to make the tabernacle: for, See, saith he, *that thou make all things according to the pattern* shewed to thee in the mount.

Heb. 8:1-5

23 *It was* therefore necessary that the patterns of things in the heavens should be purified with these; but the heavenly things themselves with better sacrifices than these.

24 For Christ is not entered into the holy places made with hands, which are the figures of the true; but into heaven itself, now to appear in the presence of God for us:

Heb. 9:23, 24

9 Which *was* a figure for the time then present, in which were offered both gifts and sacrifices, that could not make him that did the service perfect, as pertaining to the conscience;

Heb. 9:9

(παραβολή) *parabolā*
parable

(ὑποδείγμα) *hypodeigma*
copy

(σκιά) *skia*, shadow

(τύπος) *tupos*

THE ORIGINAL

(ἀντίτυπος) *anti tupos*
anti- instead of

THE ORIGINAL

--- THE TRUE

HEAVENLY THINGS THEMSELVES

And the temple of God was opened in heaven, and there was seen in his temple the ARK of his testament. *Rev. 11:19*

LAMPSTAND *Rev. 1:12*

GOLDEN ALTAR *Rev. 9:13*

BRASEN ALTAR *Rev. 6:9*

Our fathers had the *tabernacle of witness* in the wilderness, as he had appointed, speaking unto Moses, that he should make it according to the *fashion* that he had seen. *Acts 7:44*

PATTERNS of things in the heavens.

It was therefore necessary that the PATTERNS of things in the heavens should be purified with these; but the HEAVENLY THINGS THEMSELVES with better sacrifices than these. *Heb. 9:23*

FIGURES of the true.

For Christ is not entered into the holy places made with hands, the FIGURES of the true; but into HEAVEN ITSELF. *Heb. 9:24*

A COPY and SHADOW of the heavenly things.

Who serve a COPY and SHADOW of the HEAVENLY THINGS -- See, saith he, that thou make all things according to the PATTERN that was showed thee in the mount. *Heb. 8:5 A.S.V.*

A PARABLE for the time present. *Heb. 9:9*

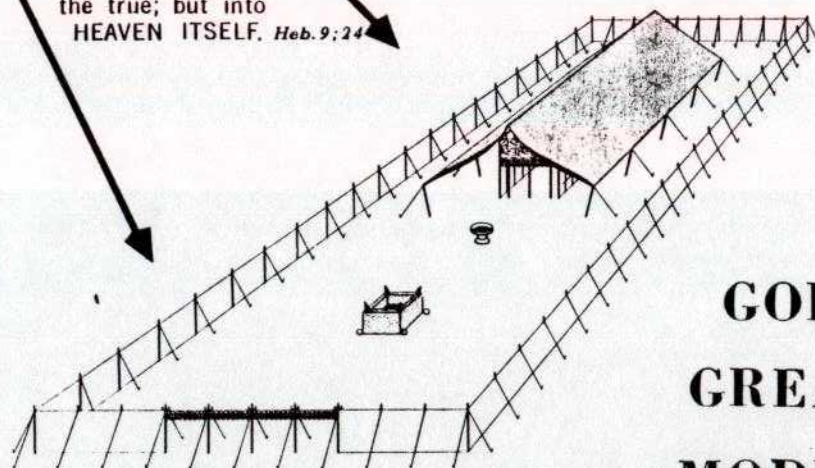

GOD'S GREAT MODEL

Speaking of the priests we are told they: "serve that which is a COPY and SHADOW of the heavenly things, even as Moses is warned of God when he is about to make the tabernacle: for, See, saith he, that thou make all things according to the PATTERN that was showed thee in the mount." *Heb. 8:5 A.S.V.*

"Copy," is here the word (*ὑποδείγμα*) which is sometimes translated, "pattern." "Shadow" is the word (*σκιά*) and is always translated, "shadow." However, the word here translated "pattern" is the word (*τύπος*) which may mean and in this case does mean the "original."

To express the purpose of the Tabernacle we find these words, "which is a FIGURE for the time present." *Heb. 9:9* The word FIGURE is the Greek word (*παραβολή*) which is usually translated, "parable." Explaining that Christ did not enter the earthly holy places, they are called "FIGURES of the true." *Heb. 9:24*. Here we find the Greek word (*ἀντίτυπος*). The Liddell and Scott, Lexicon says, "corresponding--as the stamp to the die."

So we have the words: COPY--SHADOW--PATTERN--PARABLE--FIGURE to impress on us that what we have in the Tabernacle of Witness is not just a building but an earthly duplicate of the "heavenly things themselves."

THE LAW PROPHESED

Of all the parts of the Tabernacle and furniture, the lampstand seems to be outstandingly significant. The lampstand is, even today, significant to Israel.

A student of The Word cannot help but notice the details that are given in the 9 verses of Exodus 25 and the 8 verses of Exodus 37 for the construction of the lampstand. The details of the ornaments: bowls, knops, and flowers, seem, to the average reader, to be just part of the description. But, of all the ornaments, the bowls stand out because we are told they are made like ALMONDS. Why? We are told also that there are 22. Why?

31 ¶ And thou shalt make a candlestick of pure gold: of beaten work shall the candlestick be made: his shaft, and his branches, his bowls, his knops, and his flowers, shall be of the same.

32 And six branches shall come out of the sides of it; three branches of the candlestick out of the one side, and three branches of the candlestick out of the other side:

33 Three bowls made like unto almonds, with a knop and a flower in one branch; and three bowls made like almonds in the other branch, with a knop and a flower: so in the six branches that come out of the candlestick.

34 And in the candlestick shall be four bowls made like unto almonds, with their knops and their flowers.

35 And there shall be a knop under two branches of the same, and a knop under two branches of the same, and a knop under two branches of the same, according to the six branches that proceed out of the candlestick.

36 Their knops and their branches shall be of the same: all it shall be one beaten work of pure gold.

37 And thou shalt make the seven lamps thereof: and they shall light the lamps thereof, that they may give light over against it.

38 And the tongs thereof, and the snuffdishes thereof, shall be of pure gold.

39 Of a talent of pure gold shall he make it, with all these vessels.

Ex. 25:31-39

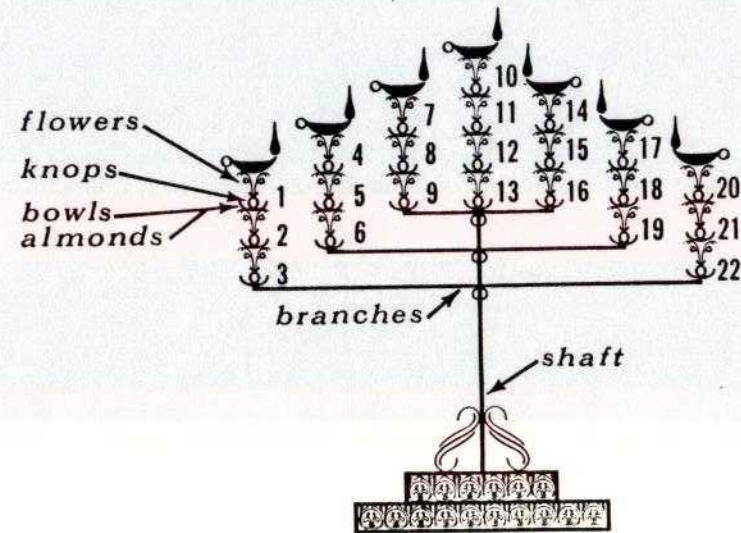

Before we can go further in the study of the lampstand it is necessary that we know a little about the tribes of Israel. The first Israelite was not Abraham nor Isaac, but Jacob. Jacob became an Israelite by God's direct command.

27 And he said unto him, What is thy name? And he said, Jacob.
28 And he said, Thy name shall be called no more Jacob, but Israel: for as a prince hast thou power with God and with men, and hast prevailed.

Gen. 32:27, 28

Jacob's name was changed to Israel, making him the first Israelite. Jacob became the father of twelve sons from which ultimately came what we know as the twelve tribes of Israel. But this is not quite that simple for in Israel's journey from Egypt to the promised land we find not twelve but in all thirteen tribes. Three tribes were camped to the east of the Tabernacle, three to the south, three to the west, and three to the north. In addition the

tribe of Levi was camped all around the Tabernacle just outside the courtfence, making thirteentribes in all. Where did the thirteenth tribe come from?

Jacob had two wives and two concubines. Since all the sons of the concubines were actually credited to the wives, we need deal only with the wives, Leah and Rachael. (Gen.29, 30) Rachael was the beloved and Leah was the hated. (Gen.29:33) Leah bore Jacob's first son, Reuben. Reuben was legally entitled to a double portion of his father's goods as the birthright. When Jacob blessed Joseph's sons he actually gave Joseph the double portion because the boys Ephraim and Manasseh became two separate tribes. In the wilderness journey there was no tribe of Joseph. This made a total of thirteen tribes rather than twelve. The legality of this shift of blessing is explained in scripture.

15 ¶ If a man have two wives, one beloved, and another hated, and they have born him children, *both* the beloved and the hated; and *if* the firstborn son be hers that was hated:

16 Then it shall be, when he maketh his sons to inherit *that* which he hath, *that* he may not make the son of the beloved firstborn before the son of the hated, *which is indeed* the firstborn:

17 But he shall acknowledge the son of the hated *for* the firstborn, by giving him a double portion of all that he hath: for he *is* the beginning of his strength; the right of the firstborn *is* his.
Deut. 21:15-17

NOW the sons of Reuben the firstborn of Israel, (for he *was* the firstborn; but, forasmuch as he defiled his father's bed, his birthright was given unto the sons of Joseph the son of Israel: and the genealogy is not to be reckoned after the birthright.

1 Chr. 5:1

Reuben — BUT —

While this accounts for a total of thirteen tribes it is now important to understand the selection of the tribe of Levi. When God slew the firstborn children of Egypt He

passed over the firstborn of Israel because of the blood on the door posts and lintel. Nevertheless the firstborn of Israel belonged to God as they were separated to God by the blood. Now the firstborn scattered throughout the entire camp could not very well serve the Tabernacle. God made a trade of the firstborn for the male Levites. Thus the Levites became God's tribe, leaving twelve tribes for Israel.

12 And I, behold, I have taken the Levites from among the children of Israel instead of all the firstborn that openeth the matrix among the children of Israel: therefore the Levites shall be mine;

13 Because all the firstborn *are* mine; *for* on the day that I smote all the firstborn in the land of Egypt I hallowed unto me all the firstborn in Israel, both man and beast: mine shall they be: I *am* the LORD.

Nu. 3:12, 13

This separation was done in a very wonderful way to teach Israel a lesson. They were told to count all the firstborn males of Israel, exclusive of the Levites, from one month and up, and the total came to exactly 22,273. Then they counted all the males of the Levites from one month and up and the total came to 22,000. God traded one for one, but as you can see there were 273 firstborn of Israel more than male Levites. These 273 firstborn of Israel were redeemed by 5 shekels of silver called the "redemption money". The word "redemption" is now being made more clear. Redemption was first by the life of another, pointing to the Lord Jesus, and also by silver. You are not redeemed with silver but with the precious blood of the Lord Jesus. (1Peter 1:18, 19)

39 All that were numbered of the Levites, which Moses and Aaron numbered at the commandment of the LORD, throughout their families, all the males from a month old and upward, were twenty and two thousand.

40 ¶ And the LORD said unto Moses, Number all the firstborn of the males of the children of Israel from a month old and upward, and take the number of their names.

41 And thou shalt take the Levites for me (I am the LORD) instead of all the firstborn among the children of Israel; and the cattle of the Levites instead of all the firstlings among the cattle of the children of Israel.

42 And Moses numbered, as the LORD commanded him, all the firstborn among the children of Israel.

43 And all the firstborn males by the number of names, from a month old and upward, of those that were numbered of them, were twenty and two thousand two hundred and threescore and thirteen.

44 ¶ And the LORD spake unto Moses, saying,

45 Take the Levites instead of all the firstborn among the children of Israel, and the cattle of the Levites instead of their cattle; and the Levites shall be mine: I am the LORD.

46 And for those that are to be redeemed of the two hundred and threescore and thirteen of the firstborn of the children of Israel, which are more than the Levites;

47 Thou shalt even take five shē'-kēls apiece by the poll, after

the shekel of the sanctuary shalt thou take *them*: (the shekel is twenty gē'-rāhs:)

48 And thou shalt give the money, wherewith the odd number of them is to be redeemed, unto Aaron and to his sons.

49 And Moses took the redemption money of them that were over and above them that were redeemed by the Levites:

50 Of the firstborn of the children of Israel took he the money; a thousand three hundred and threescore and five shē'-kēls, after the shekel of the sanctuary: ←

51 And Moses gave the money of them that were redeemed unto Aaron and to his sons, according to the word of the LORD, as the LORD commanded Moses.

Nu. 3:39-51

Firstborn Israelites →

22,273 ↘

Levites → 22,000

273

x 5 shekels

1365 ←

One more reference is necessary before we can put together what we know. God's choice of Levi was made even more emphatic during one occasion of the grumbling of the people. Each tribe laid up a rod before God. God caused the rod of the tribe of His choice to bud, blossom, and yield ripe almonds. This was the tribe of Levi and the rod of Aaron. Thus the almond designates the tribe of Levi.

The design of the almond on the lampstand connects the lampstand with the tribe of Levi.

8 And it came to pass, that on the morrow Moses went into the tabernacle of witness; and, behold, the rod of Aaron for the house of Levi was budded, and brought forth buds, and bloomed blossoms, and yielded almonds. ←

Nu. 17:8

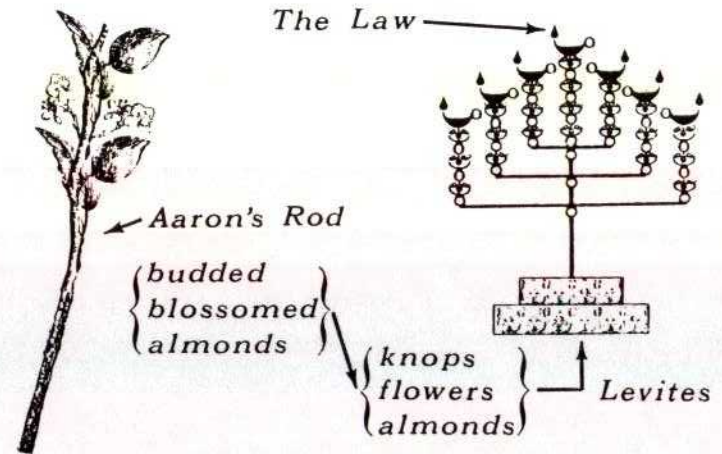

There were 12 tribes of Israel, not counting the tribe of Levi; and they were represented by the 12 loaves on the table of showbread. Not only does the almond signify the tribe of Levi, but notice that there are 22 bowls shaped like almonds; and there were 22,000 male Levites. Num. 3:39

The light on the lampstand was, to Israel, the law. No wonder David said, "Open thou mine eyes, that I may behold wondrous things out of thy LAW." Ps. 119:18 The law was God's Word and in the same Psalm, David said, "Thy WORD is a LAMP unto my feet, and a LIGHT unto my path." Psalms 119:105.

The teaching of the book of the law was entrusted to the Levites. Moses said the Levites, "shall teach Jacob thy judgments, and Israel thy law." Deut. 33:10 The book of the law was itself given to the Levites to be kept in the side of the ark. "Take this book of the law, and put it in the side of the ark of the covenant of the Lord your God, that it may be there for a witness against thee." Deut. 31:26.

At the end of every seven years, this law was taken from the ark and read during the feast of tabernacles. "And Moses wrote this law, and delivered it unto the priests the sons of Levi, which bare the ark of the covenant of the Lord, and unto all the elders of Israel. And Moses commanded them saying, At the end of every seven years, in the solemnity of the year of release, in the feast of Tabernacles, when all Israel is come to appear before the Lord thy God in the place which he shall choose, thou shalt read this law before all Israel in their hearing." Deut. 31:9-11.

Every 7 years the law was read and was represented by a lamp on the lampstand. This 7th year was a year of rest and pointed to the millennial reign of the Lord Jesus. After 7 such readings, a jubilee was proclaimed: 7 x 7 or 49 years, the 50th year being the jubilee. The ENTIRE law prophesied of Christ.

We thus see the lampstand as representing the tribe of Levi holding aloft the law which prophesied of the coming of Israel's Messiah. The Levites were to present the truth "thy law is the truth." Ps. 119:142. They were to present the law first to Israel, and also to the Gentiles. "Gather the people together, men, and women, and children, and thy STRANGER that is within thy gates, that they may hear, and that they may learn, and fear the Lord your God, and

observe to do all the words of this law." Deut. 31:12.

Israel was not obedient, and there came a time when they "put out the lamps." 2 Chr. 29:7. "Their works are in the dark." Is. 29:15 "Son of man, hast thou seen what the ancients of the house of Israel do in the dark, every man in the chambers of his imagery? for they say, The Lord seeth us not; the Lord hath forsaken the earth." Ez. 8:12.

Thus we see the beginning of the story of the lampstand, but only the beginning. The lampstand was prophetic, but soon it had its literal fulfillment. The lampstand became a reality in one single Levite, John the Baptist. To this particular Levite was given the privilege of holding forth a testimony of the TRUE LIGHT.

John's father was a priest by the name of Zacharias. His mother was also of the daughters of Aaron. Luke 1:5. The first record in the scriptures of John's testimony concerning Christ is in Matt. 3:11, 12. "I indeed baptize you with water unto repentance; but he that cometh after me is mightier than I, whose shoes I am not worthy to bear; he shall baptize you with the Holy Ghost, and with fire. Whose fan is in his hand, and he will thoroughly purge his floor, and gather his wheat into the garner; but he will burn up the chaff with unquenchable fire."

The second record of John's testimony concerning Christ is in Mark 1:7, 8. "There cometh one mightier than I after me, the latchet of whose shoes I am not worthy to stoop down and unloose. I indeed have baptized you with water; but he shall baptize you with the Holy Ghost."

The third record occurs in Luke 3:16, 17. "I indeed baptize you with water; but one mightier than I cometh, the latchet of whose shoes I am not worthy to unloose: he shall baptize you with the Holy Ghost and with fire: whose fan is in his hand, and he will thoroughly purge his floor, and will gather the wheat into his garner; but the chaff he will burn with fire unquenchable."

Certainly, it is interesting to note that one particular Levite becomes the forerunner of the Lord Jesus and his

testimony is recorded 7 times prior to the beginning of the work of the Lord Jesus. Three have already been given; the last four are in the Gospel of John.

4. "John bare witness of him, and cried, saying, This was he of whom I spoke, He that cometh after me is preferred before me: for he was before me. And of his fulness have all we received, and grace for grace. For the law was given by Moses, but grace and truth came by Jesus Christ. No man hath seen God at any time; the only begotten Son, which is in the bosom of the Father, he hath declared him." John 1:15-18.

5. "And this is the record of John, when the Jews sent priests and Levites from Jerusalem to ask him, Who art thou?-----there standeth one among you, whom ye know not; He it is, who coming after me is preferred before me, whose shoe's latchet I am not worthy to unloose." Jn. 1:19-27

6. "THE NEXT DAY John seeth Jesus coming unto him, and saith, Behold the Lamb of God, which taketh away the sin of the world. This is he of whom I said, After me cometh a man which is preferred before me: for he was before me, and I knew him not: but that he should be made manifest to Israel, therefore am I come baptizing with water. And John bare record, saying, I saw the Spirit descending from heaven like a dove, and it abode upon him. And I knew him not: but he that sent me to baptize with water, the same said unto me, Upon whom thou shalt see the Spirit descending, and remaining on him, the same is he which baptizeth with the Holy Ghost. And I saw, and bare record that this is the Son of God." John 1:29-34.

7. "AND AGAIN THE NEXT DAY after John stood, and two of his disciples; and looking upon Jesus as he walked, he saith, Behold the Lamb of God!" John 1:35, 36.

As the climax to this last witness of John, we find the tremendous statement of Andrew: "We have found the Messiah which is, being interpreted, the Christ." John 1:41 Such a statement should have been on the lips of every Israelite, but, "his own received him not." John 1:11. There

follows in John 3:19-21, the condemnation by the Lord Jesus. "And this is the condemnation, that LIGHT is come into the world, and men loved darkness rather than light, because their deeds were evil. For every one that doeth evil hateth the light, neither cometh to the light, lest his deeds should be reproved. But he that doeth truth cometh to the light, that his deeds may be made manifest, that they are wrought in God."

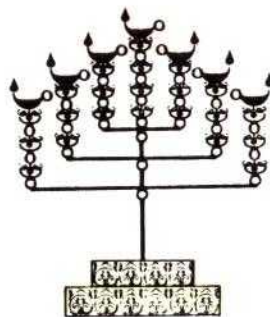

John the Baptist

- 1. Matt. 3:11,12
- 2. Mark 1:7,8
- 3. Luke 3:16,17
- 4. John 1:15-18
- 5. John 1:19-27
- 6. John 1:29-34
- 7. John 1:35-36

THE LAMB

No wonder Jesus said, "Among those born of women there is not a greater prophet than John the Baptist." Luke 7:28. The law prophesied of THE LAMB until, after 1500 years, John the Baptist stood at the crossroad of history. "Looking upon Jesus as he walked, he saith, BEHOLD THE LAMB OF GOD!" John 1:36. John, indeed, was a prophet of prophets and THE Levite who was privileged to hold aloft the Light of the World to the people of Israel.

The Law

GENESIS
EXODUS
LEVITICUS
NUMBERS
DEUTERONOMY

PROPHESIED

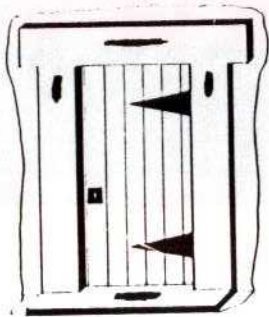

- Take a lamb. Ex. 12:3
- A male. Ex. 12:5
- Without blemish. Ex. 12:5
- Neither shall ye break a bone thereof, Ex. 12:46
- Kill it, Ex. 12:6
- In the evening, Ex. 12:6
- Strike the lintel and the two side posts with the blood, Ex. 12:22
- Eat the flesh and unleavened bread, Ex. 12:8

PROPHESIED

UNTIL John. *Matt. 11:13*

1500 Years!

THEN:-

- THIS IS MY BELOVED SON. *Matt. 3:17*
- I FIND NO FAULT IN HIM. *John 19:4*
- A BONE OF HIM SHALL NOT BE BROKEN. *John 19:36*
- THEY CRUCIFIED HIM. *John 19:18*
- WHEN THE EVEN WAS COME. *Matt. 27:57*
- THIS IS MY BLOOD-SHED FOR MANY. *Matt. 26:28*
- TAKE, EAT: THIS, IS MY BODY. *Matt. 26:26*

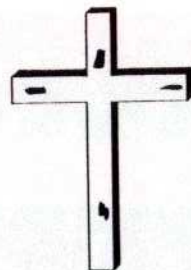

John saith,
“BEHOLD THE LAMB of GOD!”
John 1:29

After the ministry of the Lord Jesus had begun, John summed up his personal testimony in John 3:27-36, but particularly in the 36th verse, "He that believeth on the Son hath everlasting life; and he that believeth not the Son shall not see life; but the wrath of God abideth on him."
 Jesus said concerning John:

32 ¶ There is another that beareth witness of me; and I know that the witness which he witnesseth of me is true.
 33 Ye sent unto John, and he bare witness unto the truth.
 34 But I receive not testimony from man: but these things I say, that ye might be saved.
 35 He was a burning and a shining light: and ye were willing for a season to rejoice in his light.

THE LAMP, not a light
 (ὁ λύχνος) *

John 5:32-35

In reality, there are three witnesses represented in the lampstand: John, as we have already shown, the very works of the Lord Jesus, and the Father Himself. "But I have a greater WITNESS than that of John: for the works which the Father hath given me to finish, the same WORKS that I do, BEAR WITNESS of me, that the Father hath sent me. And the Father himself, which hath sent me, hath borne WITNESS of me." John 5:36, 37.

The purpose of the Gospel of John is clearly recorded in John 20:30, 31. "Many other signs truly did Jesus in the presence of his disciples, which are not written in this book: but THESE ARE WRITTEN, THAT YE MIGHT BELIEVE that Jesus is the Christ, the Son of God; and that believing ye might have life through his name." John, then, by the Holy Spirit, particularly limited his record of the signs which Jesus did. It is certainly striking that only 7 miracles are recorded before the death of the Lord Jesus.

* So the LXX: Ex. 27:20; Lev. 24:2; 1 Sam. 3:3.

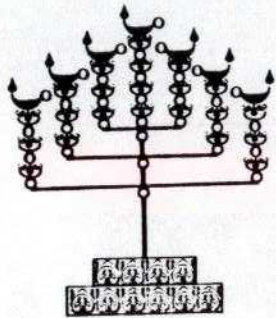

Jesus Christ

1. John 2:1-11
 2. John 4:46-54
 3. John 5:2-9
 4. John 6:1-14
 5. John 6:16-21
 6. John 9:1-41
 7. John 11:1-44
- } THE CHRIST

36 ¶ But I have greater witness than *that* of John: for the works which the Father hath given me to finish, the same works that I do, bear witness of me, that the Father hath sent me.

John 5:36

Remember, Jesus said, "THE SAME WORKS THAT I DO, BEAR WITNESS OF ME." John 5:36. But, in spite of all this testimony, Israel would not come to the LIGHT.

The witness of the Father that Jesus is His "Beloved Son," is recorded 7 times. There are three records in the Gospels of this witness at the time of the baptism of Jesus: Matt. 3:17, Mark 1:11, Luke 3:22. There are also three records in the Gospels of this testimony on the Mount of Transfiguration: Matt. 17:5, Mark 9:7, Luke 9:35. The seventh such record is entrusted to an eye witness, Peter. Peter records this testimony in direct connection with the lampstand. "This is my beloved Son, in whom I am well pleased. And this voice which came from heaven we heard, when we were with him in the holy mount. We have also a more sure word of prophecy; whereunto ye do well that ye take heed, as unto a LIGHT that shineth in a dark place, until the day dawn, and the DAY STAR arise in your hearts." 2 Peter 1:17-19.

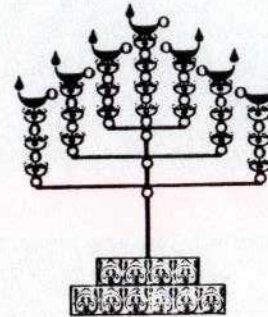

The Father

1. Matt. 3:17
 2. Mark 1:11
 3. Luke 3:22
 4. Matt. 17:5
 5. Mark 9:7
 6. Luke 9:35
 7. 2 Peter 1:17
- } THE SON

16 For we have not followed cunningly devised fables, when we made known unto you the power and coming of our Lord Jesus Christ, but were eyewitnesses of his majesty.

17 For he received from God the Father honour and glory, when there came such a voice to him from the excellent glory, This is my beloved Son, in whom I am well pleased.

18 And this voice which came from heaven we heard, when we were with him in the holy mount.

19 We have also a more sure word of prophecy; whereunto ye do well that ye take heed, as unto a light that shineth in a dark place, until the day dawn, and the day star arise in your hearts:

2 Peter 1:16-19

A LAMP →

Even though Israel had seen Jesus as the Lamb, the Christ, and the Son, they rejected their Messiah. The story of the lampstand moved on through history to represent the church. John on the isle of Patmos says, "And I turned to see the voice that spake with me. And being turned, I saw seven golden candlesticks (lampstands); and in the midst of the seven candlesticks (lampstands) one like unto the Son of man, clothed with a garment down to the foot, and girt about the paps with a golden girdle (sash)." Rev. 1:12, 13.

Notice: John saw seven lampstands. One was standing in the middle of the lampstands and, I believe, that is why he saw seven. The stand itself was hidden from his view because the One standing in the middle was the True Stand holding together as it were the seven churches.



We are told the seven lampstands are the seven churches. While these churches were seven local existing churches, they were the seven periods of church history, prophetically.

The first church, Ephesus, means "desired" or "aimed at". This was the church made up of many of those who had personally seen Jesus and it lasted until about 170 A. D.

The meaning of the second church, Smyrna, has to do with "myrrh" used in embalming for burial. This was the great martyred church which underwent great periods of persecution. It was in this period many died in the arena, fed to wild beasts or burned as living torches. This suffering church lasted until about 312 A. D.

The name of the next church, Pergamos, means "thoroughly married". This church became entangled with the idolatry of the world. It was during this period that many pagan customs found their way into church celebrations. The period of this church ran until about 600 A. D., the beginning of the Papacy.

The fourth church, Thyatira, presents the rise of the Roman Catholic Church and the mother-child religion under the name of Mary and Jesus. This church had its fall from prominence about 1500 A. D. with the rise of the fifth church period.

The fifth church, Sardis, means "those escaping" and includes the great Reformation Period with such men as Martin Luther leading the reform. This church occupied the years until about 1750 A. D.

Then came the sixth church, Philadelphia, which means "brotherly love". A great missionary zeal enlivened the church as missionaries set out to carry the gospel to the ends of the earth. This church period closed about 1920 A. D. as missionary effort became more and more restricted.

Finally, the Laodicean church took its place. This is the last of the witness of the church and is the period in which we now find ourselves. The name itself means "rights of the people". If ever there was a single word to characterize our present day, this is it. Riots, wars, and strife of all kinds as people fight for their rights. This is the poorest church of world history. God says it is "wretched, miserable, poor, blind, and naked". What a terrible condemnation of the present church. How long will it last? Till Jesus returns. But even now the witness is returning to the nation of Israel. The light of the church is going out. (Rev. 1, 2, 3)

But, even as the period of church history is closing, the nation of Israel is once more in existence on the soil of Palestine. Just as the church looks for the return of the Lord Jesus, Israel in blindness, looks for the FIRST com-

ing of their Messiah. In Zechariah 6:12 we read a prophecy of the coming of the Lord Jesus.

"Behold the man whose name is THE BRANCH." This new nation of Israel in 1958 issued a postage stamp of the lampstand without light. What a sad picture of the testimony for the Lord Jesus. But out of the center stem of the lampstand is coming a 10-leaf branch. Certainly it seems more than coincidental that the BRANCH should appear in place of the light. The story of the lampstand is nearing its close, for soon the Lord Jesus will come again.

POSTAGE STAMP OF ISRAEL



12 And speak unto him, saying, Thus speaketh the LORD of hosts, saying, Behold the man whose name is The BRANCH; and he shall grow up out of his place, and he shall build the temple of the LORD: Zech. 6:12

Through Israel's long, dark night, the word of prophecy has been shining as a lamp. One day, THE DAY STAR shall arise in their hearts.

THIRTY PIECES OF SILVER

The meaning of silver, like the meaning of the lampstand, runs all through the Bible. As in the case of the lampstand, the original meaning of silver starts in the law. In the last chapter it was shown how God by selecting the tribe of Levi as His tribe taught Israel more of the meaning of the word "redemption". Each firstborn Israelite was redeemed by the life of a male Levite but there were not enough Levites to complete the redemption. Five shekels of silver were used to redeem each one of those remaining.

47 Thou shalt even take five she'-kēls apiece by the poll, after the shekel of the sanctuary shalt thou take them: (the shekel is twenty gē'-rāhš:)

48 And thou shalt give the money, wherewith the odd number of them is to be redeemed, unto Aaron and to his sons.

49 And Moses took the redemption money of them that were over and above them that were redeemed by the Levites:

Num. 3:47-49

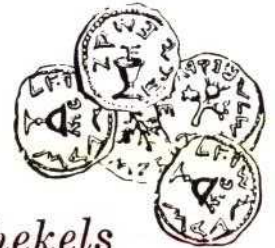

5 shekels

REDEMPTION

Silver in the law is made to have a very definite connection with the preciousness of blood. We read in Leviticus 17:11, "For the life of the flesh is in the blood; and I have given it to you upon the altar to make atonement for your souls: for it is the blood that maketh atonement by reason of the life." ASV. It must be remembered, "It is

impossible that the blood of bulls and goats should take away sins." Heb. 10:4 ASV. All these things were but shadows of the blood of the Lord Jesus which IS sufficient to take away sin. This temporary cover for sin under the law is known as atonement. While blood made an atonement, God also provided silver as an atonement.

11 For the life of the flesh is in the blood: and I have given it to you upon the altar to make an atonement for your souls: for it is the blood that maketh an atonement for the soul.

Lev. 17:11

Atonement by
BLOOD

The silver thus collected, one-half a shekel per man, was all of the silver used in the construction of the Tabernacle. Israel had just a few months before, been delivered from bondage in Egypt. There, the blood of a lamb had been put on the door posts and lintel. In those homes without the blood, the firstborn died. When the blood of the lamb, pointing to the shed blood of God's only begotten Son, was applied, the firstborn of Israel was spared. This experience must never be forgotten. Therefore, as they counted all the male Israelites that were freed from bondage by virtue of the blood, each one, as he was counted, brought one-half a shekel as a memorial offering. The rejoicing rich man could not bring any more. The poor man could not bring any less. So important are these facts that they are all recorded in great detail in the scriptures and the use of the silver carefully designated.

13 This they shall give, every one that passeth among them that are numbered, half a shē'-kēl after the shekel of the sanctuary: (a shekel is twenty gē'-rāhš:) an half shekel shall be the offering of the LORD.

Ex. 30:13

1/2 shekel
per man



14 Every one that passeth among them that are numbered, from twenty years old and above, shall give an offering unto the LORD.

15 The rich shall not give more, and the poor shall not give less than half a shē'-kēl, when they give an offering unto the LORD, to make an atonement for your souls.

16 And thou shalt take the atonement money of the children of Israel, and shalt appoint it for the service of the tabernacle of the congregation; that it may be a memorial unto the children of Israel before the LORD, to make an atonement for your souls.

Ex. 30:14-16

Atonement by
SILVER

BLOOD & SILVER

A Memorial

With the silver built into the Tabernacle in view of all, it was a constant memorial of the preciousness of the blood of that lamb that had obtained their release from bondage. It was their ransom money, their atonement money and it reminded them of redemption.

25 And the silver of them that were numbered of the congregation was an hundred talents, and a thousand seven hundred and threescore and fifteen shē'-kēls, after the shekel of the sanctuary:

26 A bē'-kāh for every man, that is, half a shē'-kēl, after the shekel of the sanctuary, for every one that went to be numbered, from twenty years old and upward, for six hundred thousand and three thousand and five hundred and fifty men.

Ex. 38:25, 26

603,550 men
x 1/2 shekel

301,775 shekels

Total silver offering 301,775 shekels.
 3000 shekels = 1 talent

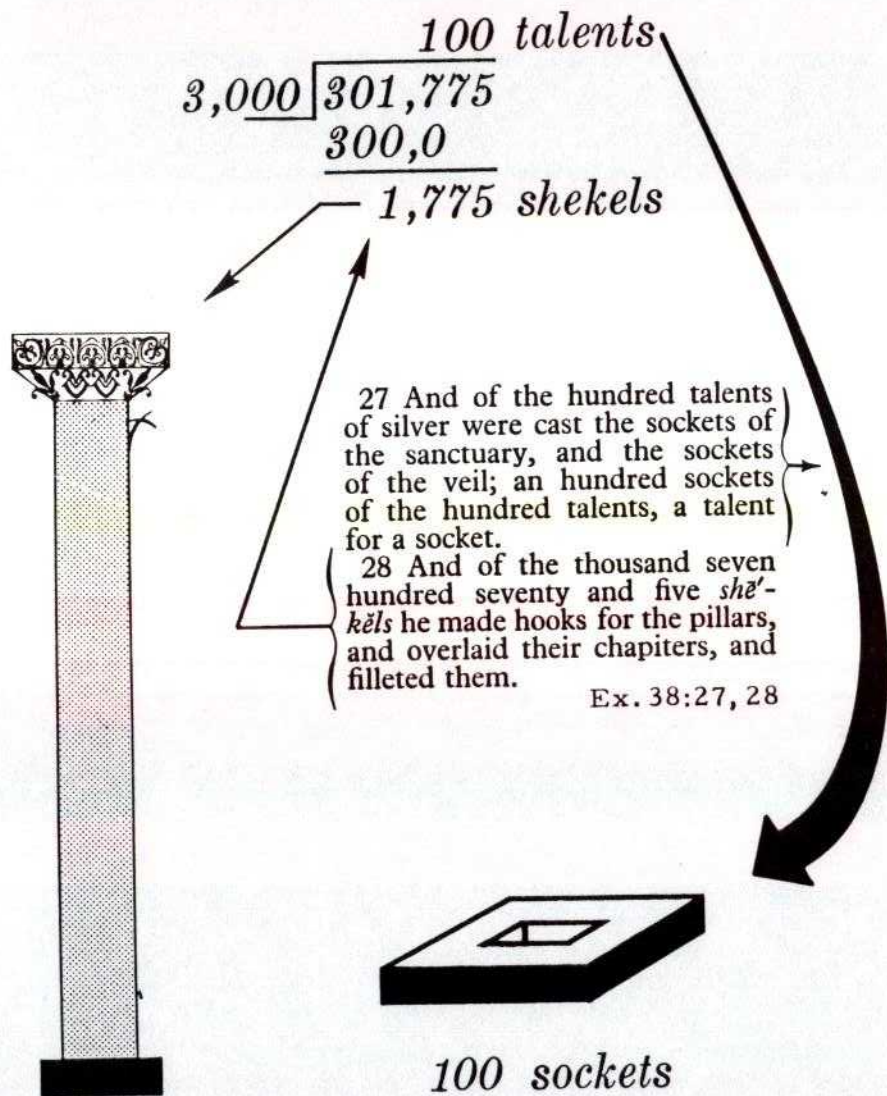

In the construction of the Tabernacle silver was used in only two places. It was used to make 100 sockets, on 96 of which rested the gold-covered boards. The other 4 sockets were put beneath the 4 pillars between the holy place and holy of holies. The small amount of silver remaining was used to overlay the capitals of the 60 court posts, to make the silver hooks for the linen fence, and the fillets. Certain facts are now established: redemption was shown by silver; atonement was by blood and by silver, showing the preciousness of blood. There is one more record in the law of a metal being used as an atonement and brought to the Tabernacle as a memorial. At the conclusion of the battle against the five kings of Median, the soldiers of Israel brought 16,750 shekels of gold jewelry which had been taken as spoil. Not an Israelite was lost in the battle. The gold was brought as an atonement and put into the Tabernacle as a memorial. This was the last battle of Moses before his death, (Num. 31)

50 We have therefore brought an oblation for the LORD, what every man hath gotten, of jewels of gold, chains, and bracelets, rings, earrings, and tablets, to make an atonement for our souls before the LORD.

→ Atonement by GOLD

54 And Moses and El-ē-ā-zär the priest took the gold of the captains of thousands and of hundreds, and brought it into the tabernacle of the congregation, for a memorial for the children of Israel before the LORD.

→ A Memorial

Num. 31:50, 54

"Forasmuch as ye know that ye were not REDEEMED with corruptible things, as SILVER and GOLD, from your vain conversation received by tradition from your fathers; but with the PRECIOUS BLOOD of CHRIST, as a LAMB without blemish and without spot." 1 Peter 1:18, 19.

In the book of Leviticus, Chapter 27, God established a very interesting silver table. Here, we find that if a man makes a "singular vow" the person vowed has a monetary value. For example: a male 20-60 years old is valued at 50 shekels of silver, a male 5-20 years is valued at 20 shekels, etc. Just what is this evaluation? How could a baby 3 months old make a vow? If the father made the vow for his child, what did this evaluation mean? All of this is practically impossible to explain except in the light of the statement of Jesus when He said, "Search the scriptures;----- they are they which testify of me." John 5:39.

Notice, in this light, a man between 20 and 60, as Jesus was, had a valuation of 50 shekels of silver. In Leviticus 27:8 we read, "But if he be poorer than thy estimation, then he shall present himself before the priest, and the priest shall value him; according to his ability that vowed shall the priest value him." But when this value was determined, then what? Leviticus 27:28,29 reads, "Notwithstanding no devoted thing, that a man shall devote unto the Lord of all that he hath, both of MAN and beast, and of the field of his possession, shall be sold or redeemed: every devoted thing is most holy unto the Lord. NONE devoted, which shall be devoted of men, shall be redeemed; but SHALL SURELY BE PUT TO DEATH."

Indeed, this is a prophecy of the death of the Lord Jesus. The LAW PROPHESED. Jesus was down-valued to the price of a slave, because He, "Made himself of no reputation, and took upon him the form of a servant." Phil. 2:7. He was the one, "Whom they of the children of Israel did value." Matt. 27:9.

Did it ever occur to you to ask why Jesus was betrayed for 30 pieces of silver? The fact that 30 pieces of silver looks small to us, gives an altogether wrong impression. This 30 shekels of silver might have amounted to as much as the wages for 120 days' work which today might be several thousand dollars. To Judas, it was a wage paid for a terrible deed. In the days of the law, it was what Judas

30
PIECES
of Silver

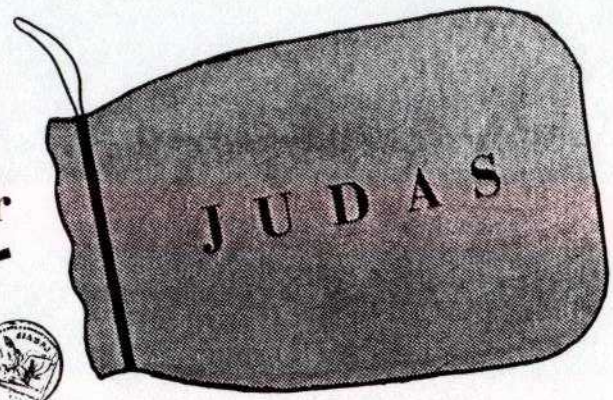

Judas cast down the pieces of silver in the temple. Matt. 27:5

The chief priests took the silver pieces, and said,

"It is not lawful to put them into the treasury." Matt. 27:6

WHY?

"It is the PRICE of blood."

? ? ?

And they took counsel, and bought with them

The Potter's Field to bury

STRANGERS.

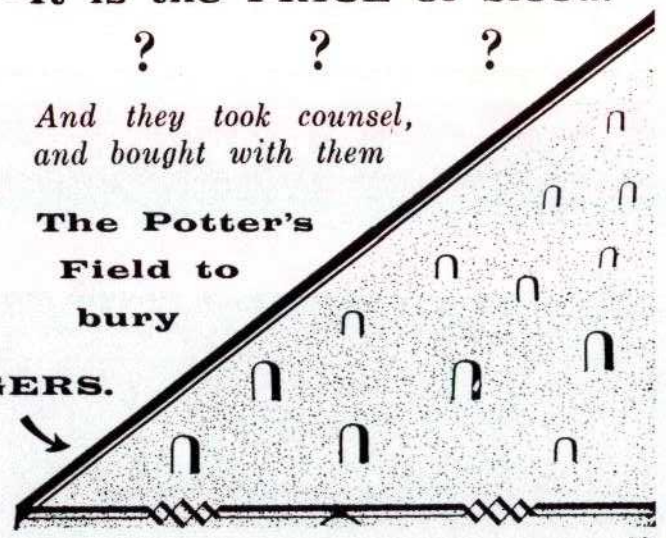

Matt. 27:7

would have received for compensation had he owned a slave which had been killed by a neighbor's bull. Ex. 21:32.

But then why would Judas need to betray Jesus at all? For more than three years Jesus had been going about Jerusalem. He was probably known to most people in the city including the soldiers. When they came and took Jesus prisoner, He said, "Are ye come out, as against a thief, with swords and with staves to take me? I was daily with you in the temple teaching, and ye took me not: but the scriptures must be fulfilled." Mark 14:48, 49. The law prophesied, and all these things were done to unfold to us the plan of salvation in all its details as contained in the law. They could have seized Jesus anytime. No payment of 30 shekels of silver was ever necessary. Judas did not have to return the money. The rulers did not have to claim that it was unlawful to put the money into the treasury. It was not necessary that they purchase a burying ground with the money. The Bible is God's Word and since all of these prophesies were contained in the scriptures, it was both necessary and wonderful that they be literally fulfilled.

When Judas cast down the 30 pieces of silver in the temple, the chief priests took the money and said, "It is not lawful for to put them in the treasury." Why? Then, came the answer. "It is the price (τιμή-preciousness) of blood." Peter says, "Unto you therefore which believe he is precious (τιμή-preciousness)." 1 Peter 2:7. Blood is precious, "For the life of the flesh is in the blood." Lev. 17:11. The blood of Jesus is much more precious.

Under law, the preciousness of blood was made a memorial in the silver of the Tabernacle. Therefore, the chief priests took the 30 pieces of silver and bought potter's field, or as we know it in the West...BOOT HILL. This was a place to bury STRANGERS in, because Jesus was a stranger here. Paul says, "Now therefore YE are no more STRANGERS and foreigners, but, fellowcitizens with the saints, and of the household of God; and are built upon the foundation of the apostles and prophets, Jesus Christ him-

self being the chief cornerstone; in whom all the building fitly framed together groweth unto an holy temple in the Lord: in whom YE also are builded together for an habitation of God through the Spirit." Eph. 2:19-22.

Were the 30 shekels a lot of money or were they a little money? Zech. 11:12, says, "If ye think good, give me my price (wage): and if not, forbear. So they weighed for my price (wage) thirty pieces of silver." This was the WAGE paid to Judas. Now, notice Zech. 11:13. "And the Lord said unto me, Cast it unto the potter: a GOODLY PRICE (preciousness) that I (Jesus) was prised (preciousness) at of them. And I took the thirty pieces of silver, and cast them to the potter in the house of the Lord." Here, the word PRICE is the word PRECIOUSNESS. What kind of a price? A GOODLY PRICE. Sometimes translated LORDLY, HANDSOME, PRINCELY, MAGNIFICENT; such is the price of 30 shekels paid for the Lord Jesus.

Why would 30 shekels be such a "GOODLY PRICE"? One more question: how would it be possible to show the worth of the Son of God in shekels? Obviously, it cannot be done. The world itself is not enough to even begin to tell the worth of the Lord Jesus. Is it not worth noting that Jesus was betrayed for 30 shekels, not 29, or 31?

Can you picture two men of Israel standing outside the court fence of the Tabernacle and looking up at the silver capitals on the 60 posts that surrounded the court? Let us call them Elizur and Nahshon. Elizur might say, "Nahshon, I brought one-half a shekel of silver to overlay the capitals of those posts and everytime I see them I remember that lamb back in Egypt. I remember how I put the blood on the door posts and lintel. What a terrible night that was! The angel of death spared my boy when he saw the blood. God redeemed us out of Egypt, but I wonder how long it will be before the Messiah comes to make us truly free."

And Nahshon might reply, "Yes, Elizur, I could have brought enough silver for the whole courtyard fence but God wouldn't permit it. I, too, could only bring one-half a

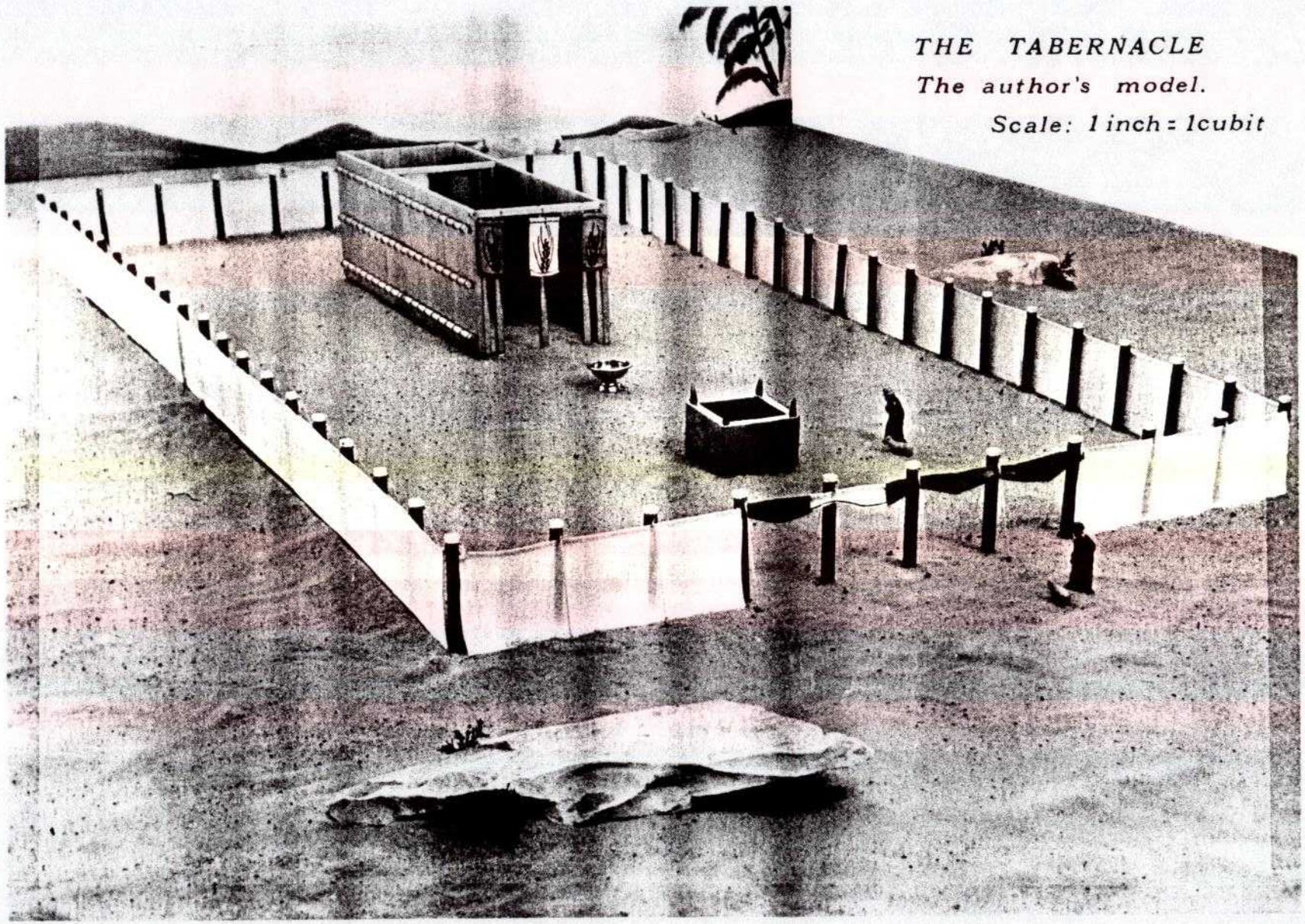

THE TABERNACLE
The author's model.

Scale: 1 inch = 1 cubit

shekel. I wonder why? Perhaps to show that God did as much for me as He did for you. Or perhaps so that every Israelite might have a part. But then, Elizur, I wonder if there isn't some further reason we do not understand."

Nahshon was right; there was another very wonderful reason. Here was how God could show the worth of His Son in a picture which He could never do with money. One-half a shekel was the ransom money for each Israelite. Jesus was betrayed for 30 shekels. God had made a vow. "Him (Jesus), being delivered by the determinate counsel and foreknowledge of God, ye have taken, and by wicked hands have crucified and slain." Acts 2:23. The value of Jesus between the age of 20 and 60 would be 50 shekels according to Lev.27, as far as God was concerned. The children of Israel agreed to pay Judas only 30 shekels, all they thought Jesus was worth. "But if he be poorer than thy estimation, then he shall present himself before the priest, and the priest shall value him." Lev.27:8. Only the price of a slave as far as Israel was concerned.

"Let this mind be in you, which was also in Christ Jesus: who, being in the form of God, thought it not robbery to be equal with God: But made himself of no reputation, and took upon him the form of a servant, and was made in the likeness of men: And being found in fashion as a man, he humbled himself, and became obedient unto death, even the death of the cross." Phil.2:5-8.

Remember: the worth of Jesus cannot be shown in money value, but by a picture God could show the worth of His Son. To God, His value was 50 shekels. Each Israelite brought one-half a shekel. Fifty shekels is 100 times one-half a shekel. The value of Jesus is 100 times as much; and under the board structure, there were just 100 silver sockets. A silver foundation for the boards, which we shall soon see, represent the believers. "For other foundation can no man lay than that is laid, which is Jesus Christ." 1 Cor.3:11.

The children of Israel valued Him at only 30 shekels.

Thirty shekels is 60 times one-half a shekel. Around the court are exactly 60 posts each with their capital of silver. Even down-valued as Jesus was by the nation of Israel, the picture of salvation is still there. "For even the Son of man came not to be ministered unto, but to minister, and give his life a ransom for many." Mark 10:45. Silver is all the way around the top of the court fence and the gate was open. This word ransom is the Greek word (λύτρον) lutron. There is another word for ransom used only once in the New Testament. It is the word (ἀντίλυτρον) antilytron. Here, I take the prefix "anti" to mean "instead of". "For there is one God, and one mediator between God and men, the man Christ Jesus; Who gave himself a RANSOM (antilytron) for all, to be testified in due time." 1 Tim.2:5,6. Instead of the price of 30 shekels, He gave His life for ALL. "None devoted, which shall be devoted of men, shall be redeemed; but shall surely be put to death." Lev.27:29.

A PLACE OF REFUGE

During the wilderness journey, the Tabernacle was the religious center for the people of Israel. They knew God's presence was a reality. All day long a great pillar of cloud hung over the Tabernacle and at night a bright pillar of fire. Never had God's presence been so clearly manifested to any people. Activity at the Tabernacle was not limited to a religious nature. All civil problems were also handled here. Moses acted as a judge and when difficult cases arose, he took his problems directly to God for disposition. God was a merciful and righteous judge. It was only natural for innocent men to take refuge in Him. To this end, God appointed a place of refuge.

12 ¶ He that smiteth a man, so that he die, shall be surely put to death.

13 And if a man lie not in wait, but God deliver *him* into his hand; then I will appoint thee a place whither he shall flee.

14 But if a man come presumptuously upon his neighbour, to slay him with guile; thou shalt take him from mine altar, that he may die.

Ex. 21:12-14

You will notice that the golden altar in the holy place was the place of refuge for the manslayer. The murderer could find no refuge anywhere. There are two cases in scripture which will illustrate the use of this place of refuge. Adonijah had planned to be king upon the death of

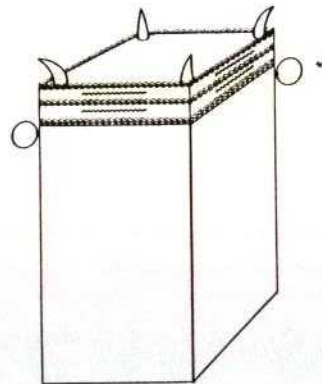

David. When Solomon was anointed king instead, Adonijah fled for refuge to the golden altar. That this was the golden altar rather than the brasen altar, is quite clear from the fact that he "caught hold on the HORNS of the altar". (1 Kings 1:50.) Notice not "a horn" but "horns". It would be quite impossible for a person to reach the horns of the brasen altar which were about seven and one-half feet apart. Further, the brasen altar would be much too hot to be a place of refuge. When it was found that Adonijah had actually done no harm, he was freed. (1 Kings 1:39-53.) A second case was that of Joab. "And Joab fled unto the Tent of Jehovah, and caught hold on the horns of the altar." 1 Kings 2:28, ASV. Here, we see the word "horns" again and also the expression "Tent of Jehovah". The "Tent of Jehovah" covered the boards and gold furniture. The brasen altar was just inside the court gate, not in the "Tent of Jehovah". Joab, being guilty of murder, was executed. God dwelt in the holy of holies and the golden altar before the second veil was as close to God as anyone might go. The only exception to this was the entry of the high priest into the holy of holies on the day of atonement. This altar then, standing inside the board enclosure, was a place of refuge.

The holy place and holy of holies were enclosed on three sides by a structure of 48 boards. We have previously covered the physical size of the boards, but one might ask: why 48 boards? What did the boards signify? By asking questions and then searching for scriptural answers, this great picture Bible will become more plain.

In the study of the lampstand we observed not one but several pictures. In the study of the silver we found many more scriptural truths in picture form. From a study of the boards we will find the same multitude of pictures.

Let us first understand the physical arrangement of the boards a little better. The position of the boards is not quite so simple as it has appeared. There are 20 boards "on the south side southward". Ex. 26:19. Then, there are 20 boards "for the second side of the tabernacle on the

28 And two boards made he for the corners of the tabernacle in the two sides.

Ex. 36:28

2

27 And for the sides of the tabernacle westward he made six boards.

Ex. 36:27

3 + 3 = 6

30 And there were eight boards; and their sockets were sixteen sockets of silver, under every board two sockets.

Ex. 36:30

2 + 6 = 8

23 And he made boards for the tabernacle; twenty boards for the south side southward:

Ex. 36:23

20

25 And for the other side of the tabernacle, which is toward the north corner, he made twenty boards,

Ex. 36:25

20

20 + 20 + 8 = 48

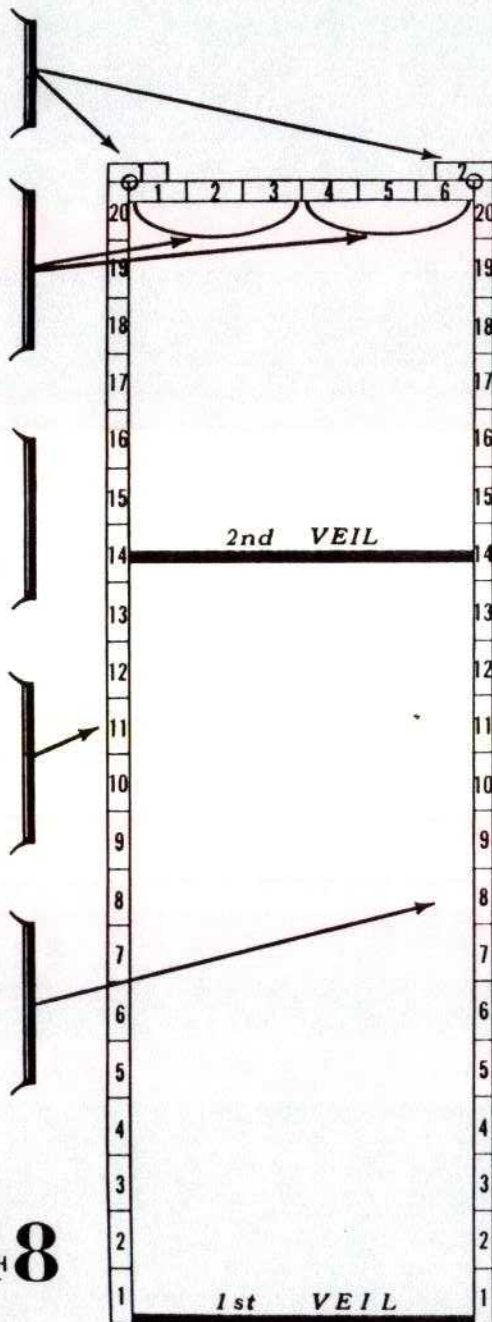

north side". Ex.26:20. "And for the sides of the tabernacle westward thou shalt make six boards." Ex.26:22. Is it not unusual to speak of a south side, a north side and west SIDES? Some translators have deliberately called it the west end or hinder part, but that is not true to the Hebrew text. Then, there were 2 corner boards. The 2 corner boards are closely associated with the 6, not the sets of 20, making 8 in all. (Ex.26:25.) Each section of 20 boards was held in place by 5 bars. The west sides were likewise held by 5 bars and the open end had 5 pillars. The drawing should help explain the numerical division of the boards.

Normally, an Israelite bringing his sacrifice would only come as far as the brasen altar in the courtyard. The tribe of Levi was very special and the priests from the tribe of Levi, ministered daily in the holy place.

Out of the nation of Israel, God set aside the Levites as His own. The Levites were in exchange for the first-born of Israel which became God's by virtue of the first passover. "And I, behold, I have taken the Levites from among the children of Israel instead of all the firstborn that openeth the matrix among the children of Israel: therefore the Levites SHALL BE MINE: because all the firstborn are mine; for on the day that I smote all the firstborn in the land of Egypt I hallowed unto me all the firstborn in Israel, both man and beast: mine shall they be: I am the Lord." Num. 3: 12, 13.

The Levites were so completely set apart to God that when the people of Israel arrived in the promised land the Levites received no part of the territorial division. Instead, the Levites were granted a total of 48 particular cities. These cities were divided in a very unusual manner.

Of the 48 cities, 6 were known as refuge cities. The purpose of these cities is stated quite plainly in Numbers 35:15. "These six cities shall be a refuge, both for the children of Israel, and for the stranger, and for the sojourner among them: that every one that killeth any person unawares may flee thither." These cities are then a

refuge in case of manslaughter. Why would a person flee to these cities? "And they shall be unto you cities for refuge from the avenger: that the manslayer die not, until he stand before the congregation in judgement." Num. 35:12. Even though a person was not guilty of murder, he still was not free. If it were judged that he was guilty of accidentally killing someone, he still had to remain in the refuge city for a certain length of time. "And the congregation shall deliver the slayer out of the hand of the revenger of blood, and the congregation shall restore him to the city of his refuge, whither he was fled; and he shall abide in it unto the death of the high priest, which was anointed with the holy oil." Num. 35:25.

It is true this system would work but there are many peculiar conditions. There is no clear scriptural example as in the case of the use of the golden altar as a refuge.

The problems can perhaps best be illustrated with a hypothetical case. Suppose as a young man twenty years old, I left my family in southern Israel and went off to seek my fortune. Just after I left home, a new brother was born to my parents. After twenty years of travel, I return home to visit and meet my brother whom I have never seen. My brother and his closest friend ask me to go to the woods to cut some logs with them. As my brother's friend is cutting a tree, his axe head comes off of the handle, striking and killing my brother. I am the revenger of blood, but I have no desire to kill my brother's best friend now in a state of shock over this terrible event. Had I not been there, what chance would I ever have had of finding my brother's friend whom I had never seen? Without radio, telephone, pictures, or police force, how could I possibly locate this man? In any event, complying with the law, I give him a head start to a city of refuge. He must remain there until the death of the high priest, but I cannot possibly spend my life making sure that he does not leave. To continue the story, some twenty years more go by and I also am guilty of manslaughter and flee to the same city. My

brother's friend has been there twenty years. Two days after my arrival, the high priest dies. We are now both free. He has spent twenty years in the refuge city; I have only been there two days. Fair? Further, one might ask, what has the high priest to do with the case? The refuge cities are divided 3 & 3. Remember, "the law prophesied" and "the law is spiritual". Note the numerical arrangement of the cities and their exact parallel to the numerics of the Tabernacle boards. Putting all these facts together, we now can arrive at the true meaning of the boards of the Tabernacle.

6 And among the cities which ye shall give unto the Levites *there shall be six cities for refuge, which ye shall appoint for the manslayer, that he may flee thither: and to them ye shall add forty and two cities.*

$$\begin{array}{r} 6 \\ + 42 \\ \hline \end{array}$$

7 So all the cities which ye shall give to the Levites *shall be forty and eight cities: them shall ye give with their suburbs.*

$$\rightarrow 48$$

11 Then ye shall appoint you cities to be cities of refuge for you; that the slayer may flee thither, which killeth any person at unawares.

12 And they shall be unto you cities for refuge from the avenger; that the manslayer die not, until he stand before the congregation in judgment.

13 And of these cities which ye shall give six cities shall ye have for refuge.

14 Ye shall give three cities on this side Jordan, and three cities shall ye give in the land of Cā'nā-ān, *which shall be cities of refuge.*

$$\rightarrow 3 + 3 = 6$$

Num. 35:6, 7, 11-14

Who has been slain? Jesus, of course. Are the children of Israel guilty of murder or manslaughter? "The God of Abraham, and of Isaac, and of Jacob, the God of our fathers, hath glorified his Son Jesus: whom ye delivered up, and denied him in the presence of Pilate, when he was determined to let him go. But ye denied the Holy One and the Just, and desired a murderer to be granted unto you; and killed the Prince of life, whom God hath raised from the dead; whereof we are witnesses. -----And now, brethren, I wot that THROUGH IGNORANCE ye did it, as did also your rulers." Acts 3:13-15, 17. Israel is guilty of manslaughter. Notice the 6 refuge cities and the 6 boards at the end of the Tabernacle. How would a person reach the 6 boards of the Tabernacle? A person might reach the golden altar but dare not go beyond, not past the veil. But our only hope is to get past that veil and reach those boards in the very presence of God. How? "That by two immutable things, (God's promise and God's oath) in which it was impossible for God to lie, we might have a strong consolation, who HAVE FLED FOR REFUGE to lay hold upon the hope set before us: which hope we have as an anchor of the soul, both sure and steadfast, and which ENTERETH INTO THAT WITHIN THE VEIL; Whither the forerunner is for us entered, even Jesus, made an high priest FOR EVER after the order of Melchisedec." Heb. 6:18-20. Jew and Gentile may now reach the very holy place itself. "Having therefore, brethren, boldness to enter into the holiest by the blood of Jesus, By a new and living way, which he hath consecrated for us, THROUGH THE VEIL, that is to say, his flesh." Heb. 10:19, 20. The law was but a shadow, "For the law made nothing perfect, but the bringing in of a better hope did; by the which we draw nigh unto God." Heb. 7:19. Once we take refuge, how long do we remain? Until the death of the High Priest. "Wherefore he is able also to save them to the uttermost that come unto God by him, seeing he EVER LIVETH to make intercession for them." Heb. 7:25.

A SHADOW OF HIS BODY

Not only is the Tabernacle a shadow of heavenly things as given in Hebrews 8:5, but also a shadow of good things to come. "For the law having a SHADOW of good things to come, and not the very image of the things, can never with those sacrifices which they offered year by year make the comers thereunto perfect." Heb. 10:1. God dwelt in the Tabernacle in the midst of His people Israel, and the very name Tabernacle means "dwelling place". This was a SHADOW of God's dwelling in the person of His Son. "For in him (Christ) dwelleth all the fulness of the Godhead bodily." Col. 2:9. That there is a shadow body of the Lord Jesus hidden back in the law seems impossible.

"Wherefore when he cometh into the world, he saith, Sacrifice and offering thou wouldest not, but a BODY hast thou prepared me: In burnt-offerings and sacrifices for sin thou hast had no pleasure. Then said I, Lo, I come (in the volume of the book it is written of me) to do thy will, O God." Heb. 10:5-7.

Notice the expression: "but a body hast thou prepared me". Heb. 10:5. This is the flesh body in which God's Son came into the world. "And the Word was made flesh, and dwelt among us, (and we beheld his glory, the glory as of the only begotten of the Father,) full of grace and truth." John 1:14. When we read that He "dwelt among us" we should read that He "tabernacled among us" for this is the true meaning. Here, we have a Greek word, eskānosen (ἐσκήνωσεν). The only other New Testament book in which this verb appears is the Revelation of Jesus Christ. Just as God dwelt in the Tabernacle of old, so Jesus tabernacled among us. This fact alone should turn our hearts back to the Tabernacle in the days of Moses for it is here

we will find the SHADOW of His body. As Hebrews Chapter 10 unfolds the short comings of the law, there is an unusual statement in verse 7. "I come (in the volume of the book it is written of me,) to do thy will, O God." This is a quotation taken by the Holy Spirit from the Psalms.

6 Sacrifice and offering thou didst not desire; mine ears hast thou opened: burnt offering and sin offering hast thou not required.

7 Then said I, Lo, I come: in the volume of the book it is written of me,

bowels

8 I delight to do thy will, O my God: yea, thy law is within my heart.

9 I have preached righteousness in the great congregation: lo, I have not refrained my lips, O LORD, thou knowest.

10 I have not hid thy righteousness within my heart; I have declared thy faithfulness and thy salvation: I have not concealed thy lovingkindness and thy truth from the great congregation.

Ps. 40:6-10

We find in Psalms 40 verse 7 the same expression as in Hebrews, "in the volume of the book it is written of me". Quite obviously we are still not in the right book. David wrote this prophetically while looking into the book he had; the law. Further hint is given of this in verses 9 and 10. "I have preached righteousness in the great congregation: lo, I have not refrained my lips, O Lord, thou knowest. I have not hid thy righteousness within my heart; I have declared thy faithfulness and thy salvation: I have not concealed thy lovingkindness and thy truth from the great congregation." Perhaps you have noticed that here are 5 attributes of God: righteousness, faithfulness, salvation, loving-

kindness, and truth. Five bars hold all of the boards together, but we will return to this later. Certainly, we know now the expression, "in the volume of the book" refers to the law and more specifically the Tabernacle. The clue to the shadow body rests in verse 8, "thy law is within my heart". It is to be regretted that this Hebrew word is here translated "heart" for it is the word "bowels" and is never in any other scripture so mistranslated.

Again, let us look into the Tabernacle, the center of all of the operations of the law. The constant reference to the west end as "the two sides westward," holds a clue. The Interlinear Literal Translation of The Hebrew Old Testament by George Ricker Berry, PH.D., renders the phrase in Exodus 26:27, "to the THIGHS, westward." The Hebrew word for side in Exodus 26:26 is a word which can be translated RIB. Each SIDE of the court gate in Exodus 27:14, 15 is the Hebrew word SHOULDER as you will see in Ex. 28:12. Here, then, we find a shadow body: shoulders, ribs, and thighs. In this area was enacted the law of the offerings. "Thy LAW is within my BOWELS." Ps. 40:8. Indeed, a shadow of that great Sacrifice, the body of our Lord Jesus Christ. The believers joined together, make up His body, the church, in the world but held out of the world by His precious blood as pictured in the silver sockets.

In the chart you will see the outline of the shadow body. All of the offerings and holydays were all shadows, as is the body outline. "Let no man therefore judge you in meat, or in drink, or in respect of an holyday, or of the new moon, or of the sabbath days: which are a shadow of things to come; BUT THE BODY IS OF CHRIST." Col. 2:17. "The Word was made flesh, and tabernacled among us." John 1:14. After Jesus arose from the dead and ascended into heaven He sent the Holy Spirit to indwell another body of Christ, the church. This transition is given and explained in the Gospel of John. "In the last day, that great day of the feast, Jesus stood and cried, saying, If any man thirst, let him come unto me, and drink. He that believeth on me, as

"One side (קֶתֶף katheph) ----- the other side." Ex.27:14,15

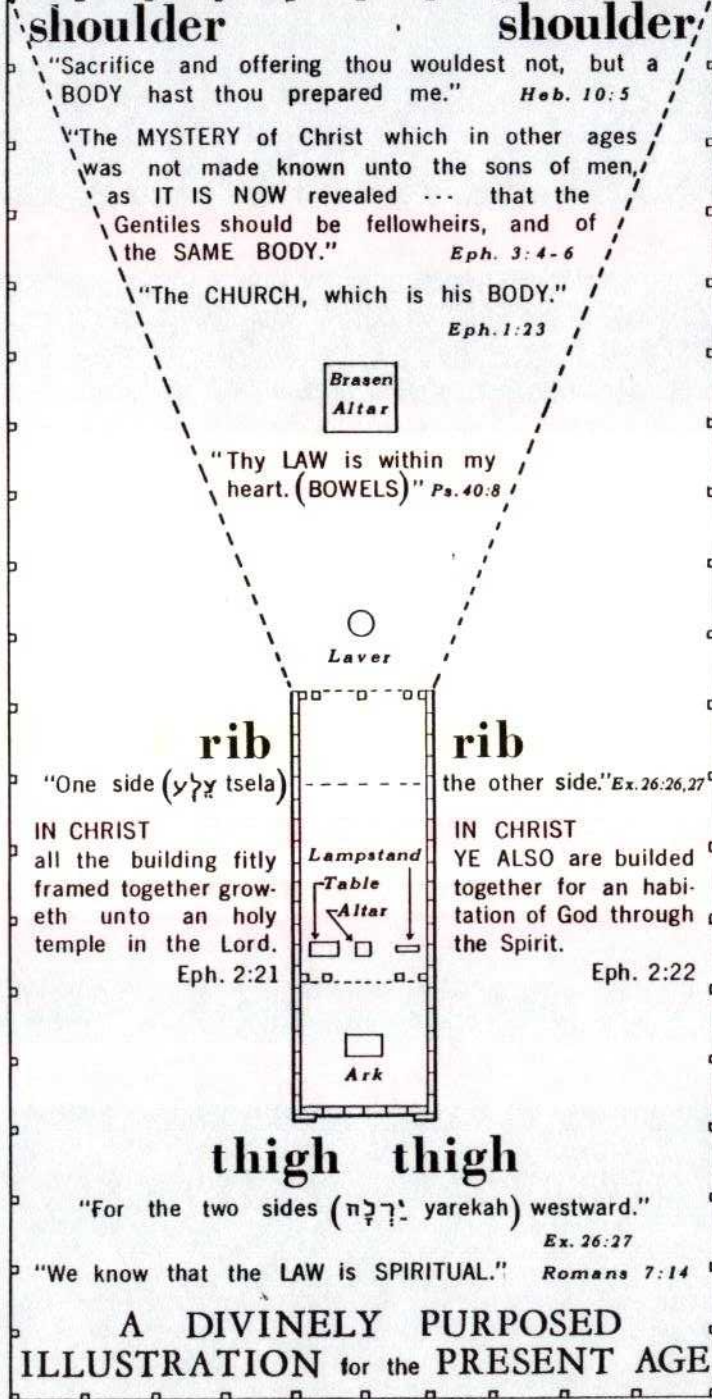

the scripture hath said, out of his belly shall flow rivers of living water." John 7:37, 38. How would rivers of living water flow out of the believer? Where is such a statement in scripture? In the Greek text there was no punctuation. These verses are not correctly punctuated. The period after the word "drink" should be after, "he that believeth on me". Thus punctuated, we have a very wonderful statement.

"In the last day, that great day of the feast, Jesus stood and cried, saying, If any man thirst, let him come unto me, and drink, he that believeth on me." Then, the rest reads as follows: "As the scripture hath said, out of his belly (Jesus) shall flow rivers of living water. (But this spake he of the Spirit, which they that believe on him should receive: for the Holy Ghost was not yet given; because that Jesus was not yet glorified.)". John 7:38, 39. Out of the shadow bowels of the Tabernacle flowed the law. After the Lord Jesus was glorified again with the Father He sent His Holy Spirit to dwell in the hearts of the believers, His body, the church.

It is well to note that the Greek uses two different words for the English word Temple. The Greek (ἱερόν -hieron) refers to the entire structure, including the court; whereas, the word (ναός-naos) refers to the inner sanctuary, God's dwelling. The boards of the Tabernacle are the NAOS; the entire structure, the HIERON. "Him that overcometh will I make a PILLAR in the TEMPLE of my God." Rev. 3:12 The word PILLAR: in the Greek Septuagint is the word for BOARD of the Tabernacle. (στῦλος).

"Know ye not that ye are the TEMPLE (ναός) of God, and that the Spirit of God dwelleth in you? If any man defile the TEMPLE of God, him shall God destroy; for the TEMPLE of God is holy, which temple ye are." 1Cor.3:16,17

And again, "In whom all the building fitly framed together groweth unto an holy TEMPLE in the Lord: in whom ye also are builded together for an habitation of God through the Spirit." Eph. 2:21,22.

In the boards then, we have a picture of the believers.

This is the mystery revealed to Paul. "Which in other ages was not made known unto the sons of men, as it is now revealed unto his holy apostles and prophets by the Spirit; That the Gentiles should be fellowheirs, and of the SAME BODY, and partakers of his promise in Christ by the gospel." Eph. 3:5, 6. Today the church is His body. (Eph. 1:22, 23.)



The law was given by Moses,
GRACE and TRUTH came by
JESUS CHRIST.

John 1:17

THAT VEIL WAS HIS FLESH

A study of the coverings presents many problems. There are a few things we know. The court is enclosed by a white linen hanging. The gate of the court is of the same material, but in color. Four different colors are in the court gate: blue, purple, scarlet, and white. The first veil at the entry to the holy place is of the same material and colors as the court gate. Both the court gate and the first veil are embroidered. What this needlework is we are not told, but Josephus said that it was of all sorts of flowers. The second veil between the holy place and the holy of holies is exactly like the other veils as far as material and color is concerned, but scripture informs us it was "with cherubims of cunning work". Ex.26:1. The first covering above, called the Tabernacle, was alike in material, colors, and cherubim to the second veil. The second covering above is the goats' hair tent. Finally, two weatherproof coverings: one of rams' skins dyed red and the other of skins dyed blue, complete the tent structure.

What did the colors of blue, purple, scarlet, and white signify? What did the goats' hair and skins represent? Perhaps we will need to make some assumptions but let us see how far we can go on scriptural interpretations.

The book of Hebrews has been called the Leviticus of the New Testament. One thing is certain: this book deals at great length with the Tabernacle and its services. In chapter 10 verse 20 we read, "By a new and living way, which he hath consecrated for us, through the veil, that is to say, his flesh". This statement is sufficient to give us a good starting place. The veil between the holy place and the holy of holies represents the "flesh" body of the Lord Jesus Christ. The location of the Tabernacle was not known

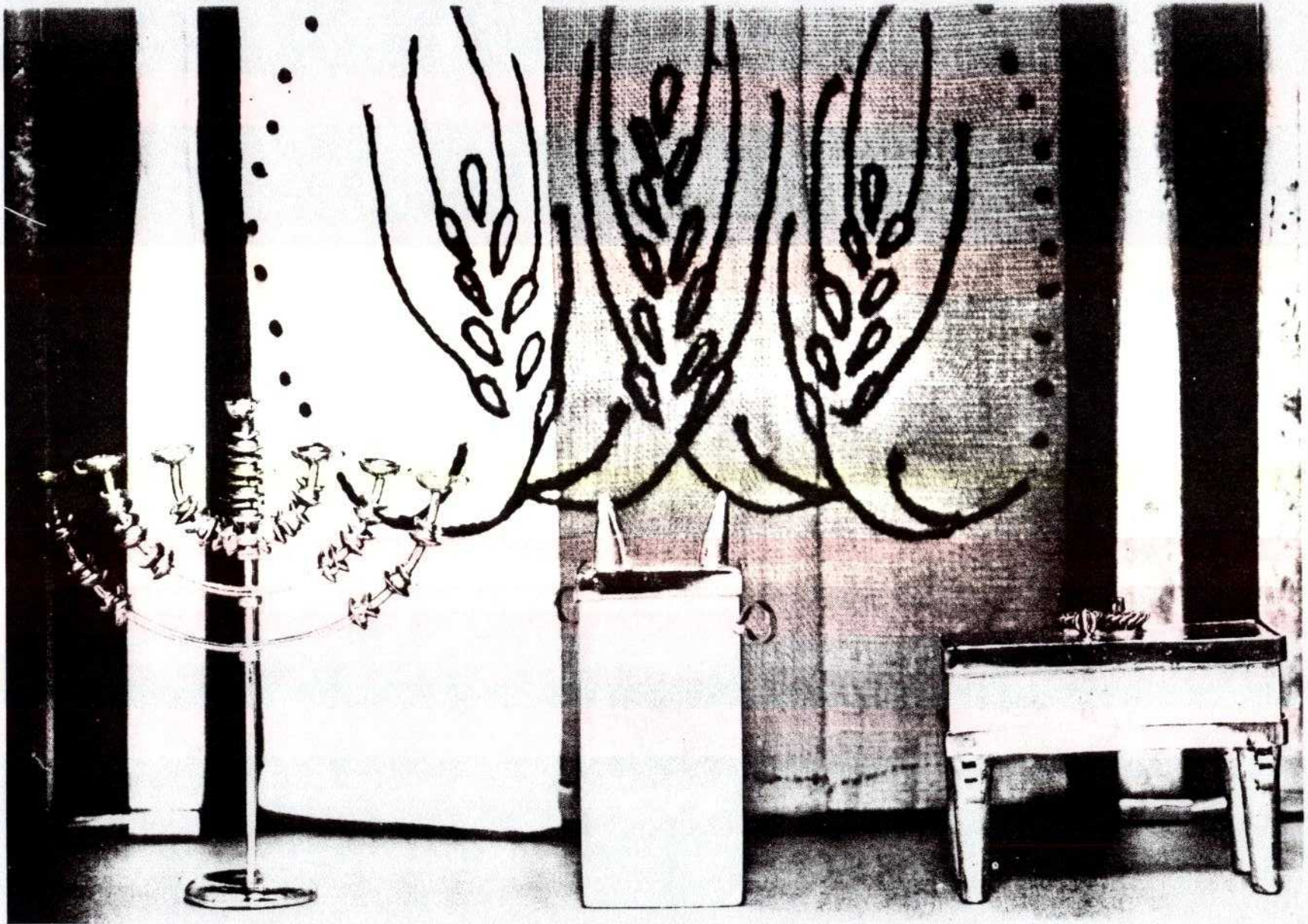

during the life of Jesus, but the services in Herod's Temple were essentially the same. Paul writes in Hebrews as though everything took place in the Tabernacle, and, in effect, it did. God never requested a temple of permanent construction.

5 Go and tell my servant David,
Thus saith the LORD, Shalt thou
build me an house for me to
dwell in?

6 Whereas I have not dwelt in
any house since the time that I
brought up the children of Israel
out of Egypt, even to this day,
but have walked in a tent and in
a tabernacle.

7 In all *the places* wherein I
have walked with all the children
of Israel spake I a word with any
of the tribes of Israel, whom I
commanded to feed my people
Israel, saying, Why build ye not
me an house of cedar?

2 Sam. 7:5-7

Tradition tells us the veil between the holy place and the holy of holies in the days of Jesus was very thick. It was this veil that was rent at the crucifixion of Jesus. "And, behold, the veil of the temple was rent in twain from the top to the bottom; and the earth did quake, and the rocks rent." Matt. 27:51. Clearly, without question, this veil represents the "flesh" body of Jesus. Since the court gate, first veil, and the Tabernacle proper are all identical also, in material and color, we may assume safely they all represent Jesus Christ in one aspect or another. Can the colors be of any help? The meaning of fine white linen is clearly stated in Rev. 19:8. "And to her was granted that she should be arrayed in fine linen, clean and white: for THE FINE LINEN IS THE RIGHTEOUSNESS OF SAINTS." But human righteousness is not thus represented. "But we

are all as an unclean thing, and all our righteousnesses are as filthy rags." Is. 64:6. The white linen can only represent the righteousness of the Lord Jesus. Scarlet, blue, and purple are all royal colors. Scarlet is often used to represent blood and is understood as blood because of association rather than by any direct statement. Scarlet also represents sin. "Come now, and let us reason together, saith the Lord: though your sins be as scarlet, they shall be as white as snow; though they be red like crimson, they shall be as wool." Isaiah 1:18. Blue has always been associated with the heavens, but there is no direct statement in scripture. Purple, in scripture, as well as in other writings is usually associated with royalty. Did Jesus ever wear any of these particular colors?

Nearly everyone remembers that before Jesus was crucified He was beaten and ridiculed. Most people remember that He was presented to the crowd, wearing a special robe. What color was the robe? How carefully do you read and study the Bible?

Generally speaking, the Roman government prided itself on justice. When, therefore, Jesus was brought before Pilate and Pilate knew this was a plot, he was anxious to avoid a decision. "For he knew that for envy they had delivered him." Matt. 27:18. Pilate's decision was immediate, "I find no fault in this man". Luke 23:4. At this decision the crowd became more fierce in their accusations. It was then that Pilate learned that Jesus was a Galilaean. Herod, the ruler of Galilee, was in Jerusalem for the feast. This gave Pilate a convenient escape, so he sent Jesus to Herod. Herod was glad to see Jesus, because he hoped Jesus would perform a miracle in his presence. When Herod learned the time for miracles was passed, and that Jesus would not even answer him, his gladness on seeing Jesus, turned to ridicule. "And Herod with his men of war set him at naught, and mocked him, and arrayed him in a gorgeous robe, and sent him again to Pilate." Luke 23:11. What color was this gorgeous robe? This

Greek word is "lampros" (*λαμπρός*), which means bright, shining, radiant. In the case of garments it refers particularly to white.* Cornelius said to Peter, "Four days ago I was fasting until this hour; and at the ninth hour I prayed in my house, and, behold, a man stood before me in BRIGHT clothing." Acts 10:30. Here, the word "bright" is the same as "gorgeous". We think of a heavenly being as dressed in white. "And the seven angels came out of the temple, having the seven plagues, clothed in pure and WHITE linen." Rev.15:6. "And to her was granted that she should be arrayed in fine linen, clean and WHITE." Rev.19:8. In these last two instances the word "lampros" is translated "white". Having mocked Jesus and clothed Him in a WHITE robe, He was returned to Pilate. Pilate continued to insist, "I find in him no fault at all." John 18:38. Again, Pilate tried to appease the unruly crowd. His soldiers scourged Jesus, and continued the ridicule and mockery started by Herod. "And the soldiers platted a crown of thorns, and put it on his head, and they put on him a PURPLE robe." John 19:2.

Pilate then presented Jesus to the crowd. "Then came Jesus forth, wearing the crown of thorns, and the PURPLE robe. And Pilate saith unto them, Behold the man." John 19:5. Just a little later Pilate presented Jesus again. This time he said, "Behold your King!" John 19:14. Here, the purple robe indicates royalty, even though it was done in mockery. The Gospel of Mark records the same purple robe in Mark 15:17.

Jesus faced His accusers in a WHITE robe as the spotless Son of God, then, in the PURPLE robe as Israel's King. Now, delivered over once again to the soldiers to prepare for the crucifixion, Jesus was clothed with a SCARLET robe. "And they stripped him, and put on him a SCARLET robe." Matt.27:28. The color of sin, the color of blood, yes, the color of royalty. Israel's King without sin was "made sin for us". 2 Cor.5:21. The only way to take away sin was by His own blood. A recent newspaper

clipping from Jerusalem read, "Under sentence to die, Adolf Eichmann put on the traditional red suit of a condemned man". Where did this tradition start? With Jesus?

Jesus wore three different robes beside His own in these last hours: WHITE-PURPLE-SCARLET but no BLUE. Why? To cloth Jesus in blue would have acknowledged that He was as He claimed to be . . . from heaven. It might also have provoked the Jews as the high priest wore a blue robe. Could it be possible that Jesus' own robe was blue? Now all these events were not all accidental. The meaning of the veils is now established beyond reason of doubt:

1. Jesus was clothed in WHITE.
2. Jesus was clothed in PURPLE.
3. Jesus was clothed in SCARLET.
4. The veil was His flesh.
5. The temple veil was rent at the death of Jesus.

This is proof enough but God has given us even more.

11 Wherefore remember, that ye *being* in time past Gentiles in the flesh, who are called Uncircumcision by that which is called the Circumcision in the flesh made by hands;

12 That at that time ye were without Christ, being aliens from the commonwealth of Israel, and strangers from the covenants of promise, having no hope, and without God in the world:

13 But now in Christ Jesus ye who sometimes were far off are made nigh by the blood of Christ.

14 For he is our peace, who hath made both one, and hath broken down the middle wall of partition between us;

15 Having abolished in his flesh the enmity, *even* the law of commandments contained in ordinances; for to make in himself of twain one new man, so making peace;

Eph. 2:11-15

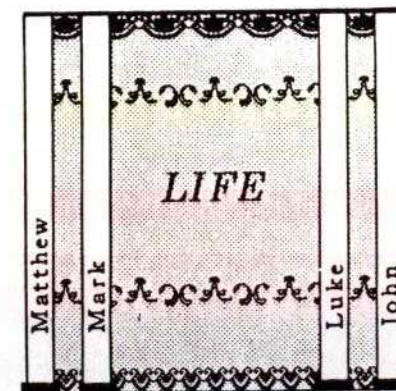

SILVER SOCKETS
REDEMPTION

Access for BOTH
JEW & GENTILE
by ONE SPIRIT

*A GREEK-ENGLISH LEXICON, Arndt and Gingrich.

16 And that he might reconcile both unto God in one body by the cross, having slain the enmity thereby:

17 And came and preached peace to you which were afar off, and to them that were nigh.

18 For through him we both have access by one Spirit unto the Father.

Eph. 2:16-18

In this scripture we are told that Gentile Christians (v. 11) were once, as Gentiles, completely without hope. But now, Gentiles who have become Christians, are made nigh by the blood of Christ. To whom were they made nigh? In verse 14 the italicized words "between us," do not occur in the Greek text and have no place here. If all Jesus came to do was to get Jews and Gentiles together, He certainly did not succeed. "For he is our peace, who hath made both one, and hath broken down the middle wall of partition." Eph. 2:14. The "middle wall of partition" separated Jew and Gentile from God. The purpose in breaking down the middle wall of partition is to "reconcile both (Jew and Gentile) unto God". Eph. 2:16. It is true Jesus also made both Jews and Gentiles into one body, the church, but the primary purpose was to reconcile both to God. This middle wall of partition is the second veil separating the holy place from the holy of holies. Now, "through the veil, that is to say, his flesh" (Heb. 10:20) we both (Jews and Gentiles) can come into the very presence of God. Here is further proof that this veil represents the earthly body of the Lord Jesus. This veil also represents the "enmity" standing between man and God. "Having abolished in his flesh the enmity, even the law of commandments contained in ordinances." Eph. 2:15. Thus in a second picture, the veil represents the law. The court gate, the first veil, the second veil, and the Tabernacle covering, represent Jesus Christ.

A PLACE OF MERCY

The Tabernacle is both a shadow of heavenly things and a shadow of good things to come. (Heb. 8:5; 10:1) This, then, is a contact between God and men. It reveals heavenly things and at the same time gives a picture of the plan of salvation which God provided in His Son so that man could attain to these very heavenly things themselves.

It is best that we first take a look at the subject as a shadow of the heavenly things. The Heavenly Tabernacle is a place of much activity. "I looked, and, behold, the temple of the tabernacle of the testimony in heaven was opened: And the seven angels came out of the temple, having the seven plagues, clothed in pure and white linen, and having their breasts girded with golden girdles (sashes)." Rev. 15:5, 6. These angels are attired in a similar garment to the priests of Israel and serve the Heavenly Tabernacle. The sashes about their breasts rather than their waists indicates a type of angelic priesthood as this is where the sashes of the Levite priests were worn.* God occupies this temple. "And the temple was filled with smoke from the glory of God." Rev. 15:8. In fact, God's throne is in this Tabernacle. "And the seventh angel poured out his vial into the air; and there came a great voice out of the temple of heaven, from the throne, saying, It is done." Rev. 16:17. Perhaps, we should note the expression "the temple of the tabernacle of the testimony in heaven was opened". Rev. 15:5. The word "temple" is here the word "naos" which we have explained is the board structure comprising the holy place and holy of holies. We are told from Josephus that the first veil was normally drawn half way up. The raising of this first veil would be the opening of the holy place of the Tabernacle of the Testimony. This

temple is not a separate building from the Tabernacle but is itself the holy part of the structure.

We would expect that God's throne in the Heavenly Tabernacle would be in the holy of holies. That is exactly what we find, for the seven lamps are before the throne. "And out of the throne proceeded lightnings and thunderings and voices: and there were seven lamps of fire burning before the throne, which are the seven Spirits of God." Rev. 4:5. The golden altar is also before the throne. "And another angel came and stood at the altar, having a golden censer; and there was given unto him much incense, that he should offer it with the prayers of all saints upon the golden altar which was before the throne." Rev. 8:3. The ark of the covenant is in the holy of holies. "And the temple of God was opened in heaven, And there was seen in his temple the ark of his testament." Rev. 11:19. These pieces of furniture are the "heavenly things themselves"...not the earthly Tabernacle taken into heaven. (Heb. 9:23) From this information it is my opinion that God's throne is on the mercyseat of the ark in heaven. We have no idea of the size of these things. The Greek word for mercyseat is "hilastāriion", (ἱλαστήριον). This word occurs only one other place in the New Testament, and is in reference to Christ. "Whom God hath set forth to be a propitiation through faith in his blood, to declare his righteousness for the remission of sins that are past, through the forbearance of God." Rom. 3:25.

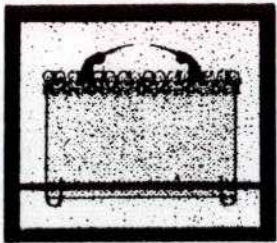

5 And over it the chēr'-ū-bims of glory shadowing the mercy-seat; of which we cannot now speak particularly.

Heb. 9:5

hilastāriion

5 Whom God hath set forth to be a propitiation through faith in his blood, to declare his righteousness for the remission of sins that are past, through the forbearance of God;

Rom. 3:25

The Lord Jesus Christ then is the "mercyseat" on the ark which at the same time is God's throne. Here, God came to dwell in the midst of His people Israel. "And there I will meet with thee, and I will commune with thee from above the mercy seat, from between the two cherubims which are upon the ark of the testimony, of all things which I will give thee in commandment unto the children of Israel." Ex. 25:22.

There were three things in the ark of the covenant in the wilderness. "The ark of the covenant overlaid round about with gold, wherein was the golden pot that had manna, and Aaron's rod that budded, and the tables of the covenant." Heb. 9:4. The word "ark" means "chest" and is even translated "coffin". (Gen. 50:26) Amazing as it may seem, all of the objects laid up in the ark seem to be directly connected with death. The first item mentioned is a pot of manna. If you remember, the children of Israel had been complaining of hunger shortly after the exodus when God fed them with manna. (Ex. 16) Why some have tried to explain manna as a product of some desert bush, is hard to understand. "---Though he had commanded the clouds from above, and opened the doors of heaven, And had rained down manna upon them to eat, and had given them of the corn of heaven. Man did eat angels' food: he sent them meat to the full." Ps. 78:23-25. A portion of this miraculous food was to be preserved. "And Moses said unto Aaron, Take a pot, and put an omer full of manna therein, and lay it up before the Lord, to be kept for your generations." Ex. 16:33. It is true that this was a memorial of God's wonderful provision, but is that the intent? The purpose is to show the insufficiency of a bread for the body even though it be provided by God. Jesus explained its meaning when He said, "Your fathers did eat manna in the wilderness, AND ARE DEAD." John 6:49. There is not much hope here. Jesus was explaining that He was the true bread. "This is that bread which came down from heaven: not as your fathers did eat manna, AND ARE DEAD: he that eateth of this bread shall live for ever." John 6:58.

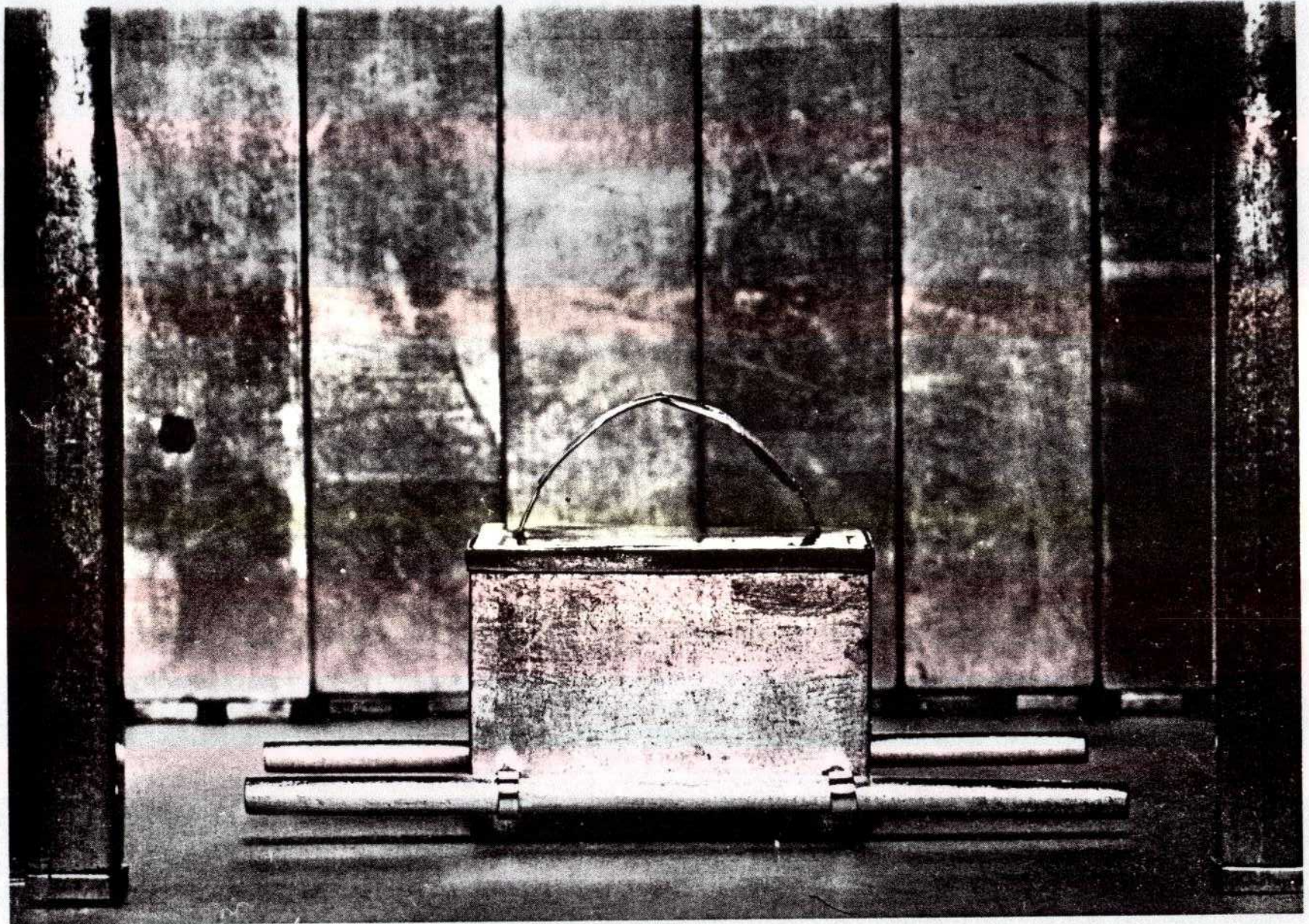

Look at Aaron's rod which budded, blossomed, and brought forth ripe almonds. Surely this speaks of life or the resurrection! Quite to the contrary, it speaks of death; for 14,700 Israelites had just died. (Num.16:49) It was to show God's choice, and God's judgment, which ended in His wrath's bringing death. "And the Lord said unto Moses, Bring Aaron's rod again before the testimony, to be kept for a token against the rebels; and thou shalt quite take away their murmurings from me, THAT THEY DIE NOT." Num.17:10. How did the children of Israel react? "Behold, we die, we perish, we all perish." Num.17:12.

What about the tables of the covenant---the two tables on which were written the 10 commandments? "For I was alive without the law once: but when the commandment came, sin revived, and I died. And the commandment, which was ordained to life, I FOUND TO BE UNTO DEATH." Rom.7:10. While the ark speaks of death so does the mercy seat speak of life and victory in Jesus Christ. "The last enemy that shall be destroyed is death." 1 Cor.15:26. "So when this corruptible shall have put on incorruption, and this mortal shall have put on immortality, then shall be brought to pass the saying that is written, Death is swallowed up in victory. O death, where is thy sting? O grave, where is thy victory? The sting of death is SIN; and the strength of sin is THE LAW. But thanks be to God, which giveth us the victory through our Lord Jesus Christ." 1 Cor.15:54-57. In the blood of Christ applied on the mercyseat, we have victory over death.

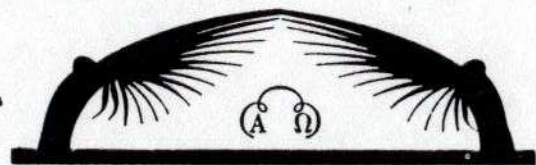

THE CLEAN AND THE UNCLEAN

At the beginning of this book we stated that the Tabernacle was a stage setting for a great drama. Thus far, we have studied the construction of the building and furniture. We have covered the meaning of some of the parts. The lampstand, for example, carries a picture throughout scripture. To this day, Israel understands the Torah, which is the Hebrew word for the "law", as the "light". It is important for us, if we are to understand what the spiritual Israelite understood, to study more of the drama which was enacted.

Long before there was a Tabernacle, there were animal sacrifices. Under the law, animals were divided into clean and unclean beasts. In Israel, this division continues to the present day. "Whatsoever parteth the hoof, and is cloven-footed, and cheweth the cud, among beasts, that shall ye eat.-----To make a difference between the unclean and the clean, and between the beast that may be eaten and the beast that may not be eaten." Lev.11:3,47. Under the law this distinction became a part in determining Israel's diet. Because of this, many persons are led to explain this difference on some health principle. This is not the case. We today eat pork, squirrel, rabbit, horse, and a great many unclean beasts with no ill effect. Many years before Moses, God separated beasts into clean and unclean groups.

"And the Lord said unto Noah, Come thou and all thy house into the ark; for thee have I seen righteous before me in this generation. Of every CLEAN BEAST thou shalt take to thee by sevens, the male and his female: and of beasts that are NOT CLEAN by two, the male and his female." Gen.7:1,2. This was nearly 4500 years ago. Even

then, it was the clean beast that was sacrificed. "And Noah builded an altar unto the Lord; and took of every clean beast, and of every clean fowl, and offered burnt-offerings on the altar." Gen. 8:20. Genesis chapter 7 is the first scriptural record we have of a direct statement concerning clean and unclean beasts. However, in Genesis chapter 4, we still find the clean beast used as a sacrifice. "And Abel, he also brought of the firstlings of his flock and of the fat thereof. And the Lord had respect unto Abel and to his offering." Gen. 4:4. In other words, there has always been this distinction between beasts.

We come now to what may seem of no importance... but in reality, is VERY IMPORTANT. Jesus is spoken of as the Lamb of God. That Jesus came and behaved like a lamb is only part of the story. Jesus created the lamb with characteristics which would give a clear picture, in advance, of His coming to suffer and die. In other words, animals were created with certain characteristics to convey to man certain truths. The three most common clean beasts are: cattle, sheep, and goats.

It is common to liken people to animals. If we mean someone is meek and docile, we say they are like a lamb. Someone that is very impolite in their eating habits we liken to a pig. Expressions as: "are you a man or a mouse?" "you're a rat," "he's a fox" are all very common and readily understood. Where does the comparing of people to animals originate? This is God's plan and has originated with God. Here are a few examples:

3 Her princes within her are roaring lions; her judges are evening wolves; they gnaw not the bones till the morrow. Zeph. 3:3

27 Her princes in the midst thereof are like wolves ravening the prey, to shed blood, and to destroy souls, to get dishonest gain.

Ez. 22:27

16 For Israel slideth back as a backsliding heifer; now the LORD will feed them as a lamb in a large place.

Hosea 4:16

11 Because ye were glad, because ye rejoiced, O ye destroyers of mine heritage, because ye are grown fat as the heifer at grass, and bellow as bulls; Jer. 50:11

The selecting of animals for sacrifice was to present a picture or drama. In scripture, the animals sacrificed to God were clean beasts. Much of this picture has been lost to our understanding because of our very limited knowledge of animals and their behavior. God's people were farmers and herdsman and were thus close to nature and saw God's hand in all they did. Few people today know the difference between a clean and unclean beast. Two characteristics mark a clean beast: it must chew the cud and have a cloven hoof. Perhaps most people are familiar with a horseshoe. It is, of course, in one piece and looks very much like the Greek letter OMEGA, (Ω). Now an oxshoe, somewhat the same, is split into two pieces, (()). The hoof of the ox is divided, or cloven, rather than solid like the horse's hoof. This split or divided hoof is a mark of a clean beast. If you notice a cow lying quietly in some field, you may observe that she seems to be chewing and, indeed, she is. A cow bites off grass at a very rapid rate and swallows it. This grass is conveniently stored until a later time. Then the cow returns this grass to her mouth and proceeds to chew it. This is known as "chewing the cud", another mark of a clean beast. To be a clean beast the animal must both chew the cud and have a cloven hoof. The camel chews the cud but it does not have a cloven hoof and, therefore, is an unclean beast. The pig has a cloven hoof but does not chew the cud and so is an unclean beast. A donkey neither chews the cud nor has a parted hoof and is unclean. A goat chews the cud and has a parted hoof and, thus, is clean.

This cleanness is not from dirt because a cow can be very dirty. Clean, in this sense, is the word pure. Both the Hebrew and the Greek word mean both clean and pure and may be translated either way. We are concerned with clean or pure in relation to God. The word unclean means defiled or polluted, again in relationship to God. The gospel story was thus shown by animals, long before there was the written Word. God has provided a record of these things so that we could understand. "And every firstling of an ass thou

shalt redeem with a lamb; and if thou wilt not redeem it, then thou shalt break his neck: and all the firstborn of man among thy children shalt thou redeem." Ex. 13:13. Here is a very simple gospel story. The ass is an unclean beast

UNCLEAN ⇌ **CLEAN**

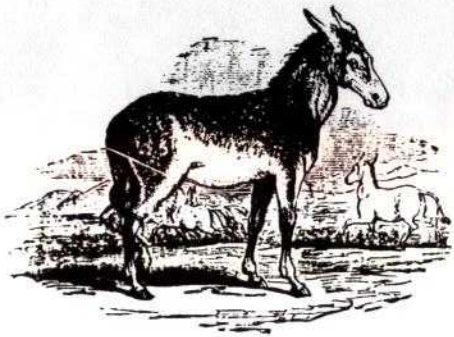

SINNER ⇌ **SAVIOR**

and, therefore, defiled before God. This then is the picture of an unbeliever. The lamb was a clean beast or pure before God and is a picture of Jesus Christ, God's Lamb. Now, unbeliever, you must be redeemed by God's Lamb. But the owner of the ass says, "I don't want to redeem the ass". God says, in effect, you don't have to; but you will have to break the neck of the ass and put it to death. Now the New Testament puts this down very plainly: "He that believeth on the Son hath everlasting life: and he that believeth not the Son shall not see life, but the wrath of God abideth on him." John 3:36.

This is a very simple picture. The Bible contains many that are much more complicated. In the book of Daniel the lion represents the Babylonian Empire, the bear represents the Medo-Persian, the leopard represents the Greek, etc. We have many Biblical comparisons between people and animals, and between nations and animals. To understand the Tabernacle, it is absolutely essential that we understand animals and their behavior. Let us see for a moment how Abraham understood sacrifices, and this, too, was long before Moses.

2 And Abram said, Lord GOD, what wilt thou give me, seeing I go childless, and the steward of my house is this El-I-ē'-zēr of Damascus?

NO CHILD

3 And Abram said, Behold, to me thou hast given no seed: and, lo, one born in my house is mine heir.

A SON PROMISED

4 And, behold, the word of the LORD came unto him, saying, This shall not be thine heir; but he that shall come forth out of thine own bowels shall be thine heir.



A SEED PROMISED

5 And he brought him forth abroad, and said, Look now toward heaven, and tell the stars, if thou be able to number them: and he said unto him, So shall thy seed be.

FAITH

6 And he believed in the LORD; and he counted it to him for righteousness.

7 And he said unto him, I am the LORD that brought thee out of Ur of the Chāl'-dées, to give thee this land to inherit it.

A LAND PROMISED

8 And he said, Lord GOD, whereby shall I know that I shall inherit it?

Gen. 15:2-8

9 And he said unto him, Take me an heifer of three years old, and a she goat of three years old, and a ram of three years old, and a turtledove, and a young pigeon.

10 And he took unto him all these, and divided them in the midst, and laid each piece one against another: but the birds divided he not.

Gen. 15:9, 10

3 YEAR OLD
HEIFER
SHE GOAT
RAM
TURTLEDOVE
YOUNG PIGEON

At this time Abraham's name was still Abram for God had not yet changed his name. Abram was concerned with the carrying on of his family for he had no children. Abram asked God about the situation and in verses 4 and 5 above, God promised not just a son but numerous descendents. Then, we see the faith of Abram, for he accepted God's Word as authority. "And he (Abram) believed in the Lord; and he (God) counted it to him (Abram) for righteousness." Gen. 15:6. In verse 8 Abram says, "Whereby shall I know that I shall inherit it?" Now Abram is not questioning God for we have already seen how Abram believed God. In effect, Abram is asking God, how this can be accomplished. Abram knows that both he and his wife are too old to have children and desires that God will give him an explanation. Abram by faith believed God, therefore, God was willing to help his understanding. "And he (God) said unto him, Take me an heifer of three years old, and a she goat of three years old, and a ram of three years old, and a turtle-dove, and a young pigeon." Gen. 15:9. Now, notice carefully that Abram knows exactly what to do with them. Abram killed the animals, "---And divided them in the midst, and laid each piece one against another: but the birds divided he not". Gen. 15:10. Abram cut up the animals and then arranged the parts in correct order as he laid them out but he did not cut up the birds. How could Abram understand by doing these things, that God was going to bless him with a great family? Abram understood the picture represented

by animals. The heifer represented his wife Sarai. (Samson refers to his wife in this manner. "---And he said unto them, If ye had not plowed with my heifer, ye had not found out my riddle." Judges 14:18.) Now notice this heifer which Abram selects is to be a 3 year old heifer. A heifer is a cow which has never had a calf. By the time a cow is 3 years old she should have had her first calf and no longer be a heifer. But you remember Sarai was old and still without a son. The she goat represented the handmaid Hagar who was an Egyptian. Hagar was not a wife in the sense of Sarai and so she is represented by a she goat, not an heifer. The 3 year old ram represents Abram well up in years. Now a ram cannot breed with a heifer. A ram speaks of the Messianic line. When Abraham went to offer up Issac it was a ram that was provided for the sacrifice. (Gen. 22) Three old animals, a heifer, a she goat, and a ram are killed and cut up. Sarai, Hagar, and Abram seemed an impossible trio for God to use as far as they were concerned. "Now Abraham and Sarah were old and well stricken in age; and it ceased to be with Sarah after the manner of women." Gen. 18:11. The turtle-dove and young pigeon were not cut up. These birds show God's mercy. It was the dove that returned to Noah with the olive leaf. (Gen. 8:11) God now showed Abram that what was impossible, was in His mercy a very simple matter. "And it came to pass, that, when the sun went down, and it was dark, behold a smoking furnace, and a burning lamp that passed between those pieces." Gen. 15:17. The burning lamp represents the Spirit of God. "And there were seven lamps burning before the throne, which are the seven Spirits of God." Rev. 4:5. God was making Abram understand that old people physically, as good as dead, by God's Spirit, could be used to bring to pass God's promises. Thus, Abram understood how God was going to bring these things to pass. This understanding of animals and the meaning attached thereto, is carried into the great drama of the Tabernacle, as we shall see.

Ample evidence has been given to show that there is a meaning derived from a kind of animal as well as its behavior. Such evidence is not limited to the Bible. There is a book called the BOOK OF ENOCH. This book is not an inspired book nor is it in any way to be compared in authority to the Bible. One portion of this book is known as THE DREAM VISIONS. This portion was written between 165 and 161 B.C. In other words, this was written about 200 years before the church. In this record, the entire history from Adam to the second coming of Christ is narrated as if individuals were animals. One outstanding fact is that Jacob and his sons are represented by sheep. This is quite consistent with the Bible. "These twelve Jesus sent forth, and commanded them saying, Go not into the way of the Gentiles, and into any city of the Samaritans enter ye not: But go rather to the LOST SHEEP of the house of Israel." Matt.10:6. The second outstanding fact is that the Adam and Seth line are represented as bulls. This, too, is quite consistent with Biblical usage. Those who are righteous are likened to calves. "But unto you that fear my name shall the Sun of righteousness arise with healing in his wings; and ye shall go forth, and grow up as CALVES of the stall." Malachi 4:2. The bull or calf became one of the major objects of worship. It was the worship of the golden calf in the wilderness that contributed to Israel's downfall. Moses said, "And I took your SIN, the CALF which ye had made, and burnt it with fire, and stamped it, and ground it very small, even until it was as small as dust: and I cast the dust thereof into the brook that descended out of the mount." Deut. 9:21. The calf presents two different pictures just as we have seen is true of many other things in our study. The calf, when worshipped, was a picture of man raising up a god of his own power. This is Satan's age-old claim. "For God doth know that in the day ye eat thereof, then your eyes shall be opened, and YE SHALL BE AS GODS, knowing good and evil." Gen. 3:5. But the calf or bullock as an offering, depicts Jesus who came to die to

pay for all the sin of the seed of Adam. "Wherefore, as by one man sin entered into the world, and death by sin; and so death passed upon all men, for that all have sinned." Rom.5:12. Adam is pictured as the bull, and Adam is a type of the Lord Jesus. When the bullock was offered in the Tabernacle, in effect, it looked back to Adam's sin. "Nevertheless death reigned from Adam to Moses, even over them that had not sinned after the similitude of Adam's transgression, who is the figure of him that was to come." Rom.5:14. When the bullock was offered on the day of atonement, the blood of the bullock was sprinkled on the mercyseat. Here, in an animal picture, is the scripture, "For as in Adam all die, even so in Christ shall all be made alive." 1 Cor. 15:22.

The only other blood ever applied on the mercyseat was that of a goat. In fact, the goat's blood was the ONLY blood ever applied for Israel's sin. The blood of the bullock was for the high priest's sin and that of his household. Here, again, we see an animal chosen partly because of its nature. The goat was created with one particular characteristic which is unusual. If a person puts his hands on the head of a goat and pushes, the goat will push back. The harder one pushes, the harder the goat pushes back. This permits the use of the goat as a wonderful picture of a sin-bearer, whereas the lamb pictures the willing substitute. As the high priest pressed with all his weight upon the head of the goat, he confessed Israel's sin. "And Aaron shall lay both his hands upon the head of the live goat, and confess over him ALL THE INIQUITIES of the children of Israel, and ALL THEIR TRANSGRESSIONS, even ALL THEIR SINS." Lev.16:21. ASV. Thus is Christ pictured as our sin-bearer. The goat stands out as an unusual offering in many ways. If Adam and righteous Gentiles are classed as bulls, and Israelites as sheep, just how does the goat fit into the picture? It is worth noting that the two goats used on the day of atonement together, comprise a single sin-offering. "And he shall take of the congregation of the

children of Israel TWO kids of the goats for (A) sin-offering and one ram for a burnt-offering." Lev. 16:5. One of these goats was killed...the other was let go into the wilderness. From these goats it is possible to arrive at a meaning of the goats' hair tent above the Tabernacle covering. Since there were two goats and two sections to the tent, and the goats were a sin-offering, it is quite natural to assume the tent represented sin. There was also a ram for a burnt-offering which pictured Jesus as a willing substitute. The covering above the tent was of rams' skins dyed red. Having one covering as a representation of sin, it is logical to take the rams' skins dyed red as a picture of the blood. The final covering of blue skins, probably also rams' skins, pictures the willing substitute from heaven or heaven itself and God's dwelling among men.

It is striking, indeed, the way the blood of the bullock and goat is so carefully connected to the blood of Christ. "Neither by the blood of goats and calves, but by his own blood he entered in once into the holy place, having obtained eternal redemption for us." Heb. 9:12. The goat is a clean beast but stands almost in a class by itself. Let us examine another characteristic of a goat. If dogs attack sheep, sheep will flee; but the goat will stand his ground and actually fight to protect the sheep. Dogs and goats are natural enemies. How wonderfully the goat pictures Jesus. "All we like sheep have gone astray; we have turned every one to his own way; and the Lord hath laid on him the iniquity of us all." Is. 53:6. Here, He is the sin-bearer. "But he was wounded for our transgressions, he was bruised for our iniquities: the chastisement of our peace was upon him; and with his stripes we are healed." Is. 53:5. And at the same time, He was the ram for the burnt-offering, a willing substitute. "He was oppressed, and he was afflicted, yet he opened not his mouth, he is brought as a lamb to the slaughter, and a sheep before her shearers is dumb, so he openeth not his mouth." Is. 53:7. The bodies of the bullock and goat whose blood was put on the mercyseat, were

burned without the camp. "And the bullock for the sin-offering, and the goat for the sin-offering, whose blood was brought in to make atonement in the holy place, shall one carry forth without the camp; and they shall burn in the fire their skins, and their flesh, and their dung." Lev. 16:27. That this is a type of the suffering and death of Jesus, is plainly stated. "For the bodies of those beasts, whose blood is brought into the sanctuary by the high priest for sin, are burned without the camp. Wherefore Jesus also, that he might sanctify the people with his own blood, suffered without the gate." Heb. 13:11, 12. This is the continuing picture of the goat, and the natural enmity between goats and dogs helps to explain the picture. "For dogs have compassed me: the assembly of the wicked have inclosed me: they pierced my hands and my feet." Ps. 22:16. The bullock pictures Jesus as the son of Adam; the lamb pictures Jesus as the son of Abraham, Isaac, and Jacob. The goat pictures Jesus as the Son of God.

The separation of clean and unclean beasts was never intended as simply a diet regulation from the standpoint of health. It was a diet imposed under the law, but for the purpose of teaching spiritual things. God's first instruction to Noah proves this very plainly. "Every moving creature that liveth shall be meat for you." Gen. 9:3. Lest there be any further doubt, this matter is explained more fully to Peter. Peter was hungry and he saw a great sheet let down from heaven. "Wherein were all manner of fourfooted beasts of the earth, and wild beasts, and creeping things, and fowls of the air. And there came a voice to him, Rise, Peter; kill, and eat. But Peter said, Not so, Lord; for I have never eaten anything that is common or unclean. And the voice spake unto him again the second time, What God hath cleansed, that call not thou common." Acts 10:12-15. This sheet was let down three times. Peter understood that these unclean beasts represented the Gentiles. For even while he was meditating on these things, three men came to his door. "And he said unto them, Ye know how it is an

unlawful thing for a man that is a Jew to keep company, or come unto one of another nation; but God hath shewed me that I should not call any man common or unclean." Acts 10:28.

This was clearly understood by the early Christians. Clement of Alexandria in THE INSTRUCTOR, book 3, chapter 11, writes: "For the parting of the hoof indicates the equilibrium of righteousness, and ruminating points to the proper food of righteousness, the word, which enters from without, like food, by instruction, but is recalled from the mind, as from the stomach, to rational recollection. And the spiritual man, having the word in his mouth, ruminates the spiritual food; and righteousness parts the hoof rightly, because it sanctifies us in this life, and sends us on our way to the world to come".

Irenaeus in his work against heresies chapter 8, section 4, writes: "Who then are the clean? Those who make their way by faith steadily towards the Father and the Son; for this is denoted by the steadiness of those which divide the hoof; and they meditate day and night upon the words of God, that they may be adorned with good works: for this is the meaning of the ruminants". (Those that chew the cud.)

As early as 100 A.D. in the EPISTLE of BARNABAS, we have the same understanding. "---those who know that meditation is a work of gladness, and who ruminate upon the word of the Lord. But what means the clovenfooted? That the righteous man also walks in this world, yet looks forward to the holy state (to come)."

At the beginning of this book we pointed out that the Tabernacle was the most unusual stage setting, drama, and parable that has ever existed. The study of the Tabernacle becomes complex because all parts of the structure point to Christ and the plan of salvation, while at the same time, all the stage settings and sacrifices themselves represent Christ. Now, in addition, the actors themselves were a type of Christ which further complicates the study. Not only is the principle actor, the high priest, a direct

type of Christ, but his entire garment as well as his actions portray Christ and the plan of salvation. With this in view we now must necessarily turn our attention to the garments of the high priest.



"Think not that I am come to destroy the LAW, or the prophets: I am not come to destroy, but to fulfil."

Matt. 5; 17

THE GARMENTS OF THE HIGH PRIEST

The high priest had two sets of garments. The most elaborate were those worn in his daily administrations. This set of garments consisted of a breastplate, an ephod, a robe, a brodered coat, a mitre, and a sash, plus a simple undergarment. (Ex. 28:4, 42) The second set of garments were only used one day.* New garments were made the following year for the next day of atonement. This set was comprised of a holy linen coat, linen breeches, a linen sash, and a linen mitre. (Lev. 16:4) You will notice that in either set of garments no footwear of any kind is provided, for this ground was holy ground. Moses at the burning bush had heard God's command. "Draw not nigh hither; put off thy shoes from off thy feet, for the place whereon thou standest is holy ground." Ex. 3:5. The set used for the day of atonement was plain without precious stones or gold embroidery. It emphasized the righteousness of a Holy God. It is in these garments that the high priest is the nearest representation of Jesus Christ. The only gold is the plate fastened with blue lace to the mitre, or head cover. On this plate were engraved the words, "HOLINESS TO THE LORD". (Ex. 28:36) While the daily garments of the high priest were outstanding, the real distinction rested in this gold plate or crown. Only the wearer of this crown could ever enter the holy of holies. "And it shall be upon Aaron's forehead, that Aaron may bear the iniquity of the holy things, which the children of Israel shall hallow in all their holy gifts; and it shall be ALWAYS upon his forehead, that they may be accepted before the Lord." Ex. 28:38.

The first garment described is the Ephod. Ex. 28:6-14. It was made of blue, purple, scarlet, and white linen with

gold, worked into the fabric. "And they did beat the gold into thin plates, and cut it into wires, to work it in the BLUE, and in the PURPLE, and in the SCARLET, and in the FINE LINEN, with cunning work." Ex. 39:3.

The colors are the same as those in the structure itself. On the shoulders were set two onyx stones, on which were engraved the names of the children of Israel, "And thou shalt put the two stones upon the shoulders of the ephod for stones of memorial unto the children of Israel: and Aaron shall bear their names before the Lord upon his two shoulders for a MEMORIAL." Exodus 28:12. The shoulder is the place of burden; and, indeed, Israel was a burden to the Lord.

Fastened to the ephod, was a breastplate of judgment. On this breastplate were twelve precious stones on which were the names of the children of Israel. This was over his heart, the place of affection. Great, indeed, was God's love for Israel. "And Aaron shall bear the names of the children of Israel in the breastplate of judgment upon his HEART, when he goeth in unto the holy place, for a MEMORIAL before the Lord continually." Ex. 28:29.

The ephod itself was a sort of sleeveless jacket, but the breastplate was rather permanently fastened to it. The breastplate was about nine inches square when assembled; but when opened out, it was nine inches wide and eighteen inches long. Folded in the middle and fastened to the front

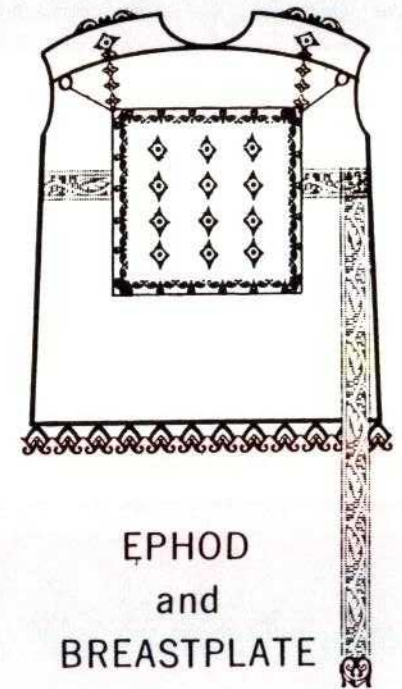

*THE TEMPLE, Dr. Alfred Edersheim, D. D., Ph. D.

of the ephod with gold chains and blue lace, it resembled an elaborate muff into which the hands could be put from either side. What has been one of the most difficult verses to explain is in connection with this breastplate. "And thou shalt put in the breastplate of judgment the Urim and the Thummim; and they shall be upon Aaron's heart, when he goeth in before the Lord: and Aaron shall bear the judgment of the children of Israel upon his heart before the Lord continually." Ex.28:30. What were the Urim and the Thummim? These are what are known as transliterated words. They are actually Hebrew words spelled with English letters but not translated. They can be translated, and simply mean "lights and perfections". We are no nearer a solution. What are the lights and perfections which were put into the breastplate?

A very possible explanation is given by David Baron in a small work on THE URIM AND THUMMIM, David Baron explains that there were not sufficient letters in the names of the tribes engraved on the precious stones to make a complete Hebrew alphabet. Therefore, four extra stones were put in the sides of the breastplate, each engraved with a single letter. These were the Thummim or completions. The Urim was a Divine light of some sort which kept the stones lit up and shining. When Moses was alive and a case occurred which required God's judgment, Moses simply went in and talked to God. After Moses died, the case was quite different. Now, when judgment was required, it was the breastplate which was used to give the answer. "Now after the death of Joshua it came to pass, that the children of Israel asked the Lord, saying, Who shall go up for us against the Canaanites first, to fight against them"? Judges 1:1. The high priest asking God this question would now look at his breastplate and the stone of Judah would be dark. This, David Baron explains is the answer from God. "And the Lord said, Judah shall go up: behold, I have delivered the land into his hand." Judges 1:2.

There are some problems with this explanation but it

does have some merit. At any event we know that the ephod was consulted for God's counsel and is very important to Israel. "For the children of Israel shall abide many days without a king, and without a prince, and without an image, and without an EPHOD, and without teraphim." Hosea 3:4.

It is better to study the robe of the ephod from the bottom up, for the pomegranates which are between the golden bells hold the key to the garments of the High Priest.

"And beneath upon the hem of it (the robe) thou shalt make pomegranates of blue, and of purple, and of scarlet, round about the hem thereof: and bells of gold between them round about: A golden bell and a pomegranate, a golden bell and a pomegranate, upon the hem of the robe round about. And it shall be upon Aaron to minister: and his sound shall be heard when he goeth in unto the holy place before the Lord, and when he cometh out, that he die not." Ex. 28:33-35

The primary purpose of any bell is to call attention. In this case, the bells being placed between the pomegranates are, first of all, to call attention to the pomegranates, and secondly, to the entire garment and service of the High Priest. It will be noted the colors of the pomegranates are not their natural color, for they are blue, purple, and scarlet.

The Hebrew word for pomegranate is rimmon. We find the House of Rimmon referred to in 2 Kings 5:18. Here, Naaman, having been healed by Elisha, petitions the Lord to forgive him for going into the House of Rimmon.

"In this thing the Lord pardon thy servant, that when my master goeth into the house of Rimmon to worship there, and he leaneth on my hand, and I bow myself in the house of Rimmon: when I bow down myself in the house of Rimmon, the Lord pardon thy servant in this thing."

What was the House of Rimmon, or pomegranate? In all likelihood a temple of Astarte, for Astarte is frequently represented on ancient medals with the pomegranate in her hand. (See Fig.) A more lengthy account may be found in THE TWO BABYLONS by Rev. Alexander Hislop, p.111.

Since Astarte is represented as the Mother of Knowledge, it is quite obvious that the fruit represents the source of knowledge, or the tree of knowledge of good and evil in the Garden of Eden.

Nowhere in scripture do we find the rimmon or pomegranate stated to be the fruit of that tree. But the Bible does mention, a House of Rimmon, and Naaman knew it was wrong to bow down in The House of Rimmon. Why?

When the pomegranate is understood as the fruit of the tree of knowledge of good and evil, all becomes more clear.

It is of more help to note Israel roasted the passover lamb on a pomegranate spit. See, *THE LIFE AND TIMES OF JESUS THE MESSIAH*, by Dr. Alfred Edersheim, Book 5, chapter 9.

Since it was the eating of this fruit in disobedience that caused The Fall, it now seems reasonable that the pomegranates on the robe not only announce The Fall but by their color, the cost of that Fall. The blue, because the Lord from Heaven had to leave His heavenly home. The purple, for the hard hearts in Israel cost the rejection of the King. The scarlet, for the sin cost God's Son His own blood. The ringing of the bells tell the fact that there is redemption from this Fall. The blue robe pictures the Lord of Glory who became flesh and dwelt among us.

"For ye know the grace of our Lord Jesus Christ, that, though he was rich, yet for your sakes he became poor, that ye through his poverty might be rich." 2 Cor. 8:9.

Specific instructions are given that there be a woven work around the neck so that it would not tear. The same



ASTARTE

statement is made regarding the coat of the Lord Jesus, "Let us not rend it." John 19:24. Different colors of robes were put on Jesus, as Herod and Pilot ridiculed the Lord. First, the GORGEOUS robe, Luke 23:11, a word which is translated WHITE in Rev. 15:6 and Rev. 19:8. Then, the PURPLE; and finally, the SCARLET. Is it possible that He wore a BLUE robe of His own? Or, did they reject the idea of the BLUE robe because they did not accept Him as the Son of God, the Lord from Heaven?

It is worthwhile to take another look at the special woven work around the neck of the robe of the ephod with the specific instructions, "that it be not rent". Ex.28:32. It was customary for anyone to display unusual grief by the rending of their clothes. Aaron was the first high priest of Israel. Two of Aaron's sons, Nadab and Abihu, sinned against God by offering strange fire. (Lev.10) "And there went out fire from the Lord, and devoured them, and they died before the Lord." Lev.10:2. Aaron and his remaining sons were ordered to refrain from rending their garments and mourning for Nadab and Abihu. "And Moses said unto Aaron, and unto Eleazar and unto Ithamar, his sons, Uncover not your heads, NEITHER REND YOUR CLOTHES; lest ye die, and lest wrath come upon all the people: but let your brethren, the whole house of Israel, bewail the burning which the Lord hath kindled." Lev.10:6. Thus, God emphasized the fact that the robe was not to be rent. This fact is stated as a matter of law in Lev.21:10. "And he that is high priest among his brethren, upon whose head the anointing oil was poured, and that is consecrated to put on the garments, shall not uncover his head, NOR REND HIS CLOTHES."

It was just beginning to dawn when Jesus was brought before Caiaphas. This was the time of the morning sacrifice. The Lamb of God stood facing the high priest of Israel. It was Caiaphas who had prophesied that the Lamb of God must die for the people. "And one of them, named Caiaphas, being the high priest that same year, said unto them, Ye

know nothing at all, Nor consider that it is expedient for us, that one man should die for the people, and that the whole nation perish not. And this spake he not of himself: but being high priest that year, he prophesied that Jesus should die for that nation; And not for that nation only, but that also he should gather in one the children of God that were scattered abroad." John 11:49-52. Now was the hour when The Lamb must die. Caiaphas heard the accusations; and then filling prophecy to the utmost, he rose and he himself questioned Jesus.

In Greek the word for Christ is *Christos* (*Χριστός*). This word also means the Messiah or the Anointed. This is the word sometimes used in the Septuagint for the anointed priest. (When referring to the high priest.) In Lev. 4:5 and Lev. 4:16 our Bible reads, "the priest that is anointed". The Greek reads, "the priest namely the Anointed," or "the priest namely the Messiah," or "the priest namely the Christ". (*ὁ ἱερεὺς ὁ χριστός*).

Now comes the final question of Caiaphas the high priest. "Art thou the Christ the Son of the Blessed"? Mark 14:61. I believe, the morning sacrifice had just been offered in the temple as Jesus gave His answer. "I AM: and ye shall see the Son of man sitting on the right hand of power, and coming in the clouds of heaven." Mark 14:62. The last of the continual lamb burnt-offerings was finished and the Lamb of God was about to be offered. Caiaphas took hold of the woven work around the neck of the robe and with a mighty pull, rent his garments. "Then the high priest RENT HIS CLOTHES." Mark 14:63. The Levitical priesthood was ended. A new High Priest was soon to be inaugurated. It was that day at the evening sacrifice that the Lamb of God died replacing forever the first covenant. Jesus, the High Priest of the Heavenly Tabernacle, by His own blood put into operation the heavenly things themselves. Even while Jesus was dying on the cross the soldiers took His coat and said, "Let us not rend it". John 19:24.

The picture of the high priest is taken from Kitto's,

HISTORY OF THE BIBLE. The sash shown around his waist should be high around his chest as shown in the drawing, passing under the breastplate on the ephod.



Fastened to the mitre, the head covering, was a plate of gold on which was engraved HOLINESS TO THE LORD. "And it shall be upon Aaron's forehead, that Aaron may bear the iniquity of the holy things, which the children of Israel shall hallow in all their holy gifts; and it shall be always upon his forehead, that they may be accepted before the Lord." Exodus 28:38.

Aaron, the High Priest, accepted the guilt of all of the offerings; and because he wore the gold crown, he was accepted by God. In this same manner, we also are accepted by God. "To the praise of the glory of his grace, wherein he hath made us accepted in the beloved." Eph. 1:6.

The garments tell a complete story from the Fall in the Garden of Eden; to the coming of the Lord Jesus; to His sacrificial death; to His coming as Judge; and to His coming as King of Kings and Lord of Lords.

We can easily see that the high priest was a type of Christ and that His garments tell the gospel story. The bells were never worn in the holy of holies, but only in the holy place. Notice when they were to ring. "And it shall be upon Aaron to minister: and his sound shall be heard WHEN HE GOETH IN UNTO THE HOLY PLACE before the Lord, and WHEN HE COMETH OUT, that he die not." Ex. 28:35. It was not necessary that they ring when he was in the holy place but only as he came and went. The bells called attention, not to the man, but to the garments which made him a type of Christ.

The following incident recorded by Josephus in his ANTIQUITIES OF THE JEWS, Book 11, Chapter 8, makes this very clear. As the great conquering general, Alexander the Great, approached the city of Jerusalem, he was met by the High Priest. "...Alexander, when he saw the multitude at a distance, in white garments, while the priests stood clothed with fine linen, and the high priest in purple and scarlet clothing, with his mitre on his head, having the golden plate whereon the name of God was engraved, he approached by himself, and adored that name, and first

saluted the high priest. The Jews also did all together, with one voice, salute Alexander, and encompass him about; whereupon the kings of Syria and the rest were surprised at what Alexander had done, and supposed him disordered in his mind. However, Parmenio alone went up to him, and asked him how it came to pass that, when all others adored him, he should adore the high priest of the Jews? To whom he replied, 'I did not adore him, but that God who hath honoured him with his high priesthood; for I saw this very person in a dream, in this very habit, when I was at Dios in Macedonia, who, when I was considering with myself how I might obtain the dominion of Asia, exhorted me to make no delay, but boldly to pass over the sea thither, for that he would conduct my army, and would give me the dominion over the Persians; whence it is that, having seen no other in that habit, and now seeing this person in it, and remembering that vision, and the exhortation which I had in my dream, I believe that I bring this army under the Divine conduct, and shall therewith conquer Darius, and destroy the power of the Persians, and that all things will succeed according to what is in my own mind.'" The garments form a picture of the redemptive work of the Lord Jesus.

But listen to the ringing of the bells, as the High Priest goes into the Holy Place. What do they say, "Listen, Israel, there is one to bear your sin even your Messiah." And as he comes out, "Listen, Israel, your Messiah comes." Yet, in spite of the shadows of the Messiah in the garments of the High Priest, "His own received Him not." John 1:11.

POMEGRANATES
 THE FRUIT of THE TREE
 of KNOWLEDGE of
 GOOD and EVIL.

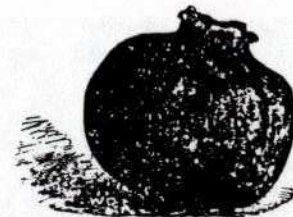

THE SERVICE OF THE LEVITES

As we have seen, the Levites were separated from Israel. This tribe was assigned the task of caring for and transporting the Tabernacle of the Congregation. Levi had three sons: Gershon, Kohath, and Merari. The care of the Tabernacle was allotted to these three families. To the family of Gershon was assigned the Tabernacle itself. The Tabernacle as we have seen, consisted of 10 linen curtains, blue, purple, scarlet, and fine linen. Two sections of 5 curtains each were coupled together with 50 gold clasps. We have seen that whenever these colors occur together, they represent Jesus Christ, and the Tabernacle covering is no exception. Just what phase of the life of Jesus does it represent?

This was the first part of the structure in which God instructed Moses. It represents Jesus Christ in His first advent, His crucifixion, and the end of the law. Five is the predominating number in the Tabernacle and seems to represent the law. Because the five books of Moses bear Greek names, it has been argued that this division was arrived at only at a later date. I believe Moses received five books as we have them now, and, as we know, they existed at least 250 years before Christ. There were two tables of the covenant on which were written the 10 commandments. Here, again, the church has arbitrarily assumed a division of 4 and 6 on each of the two tables, respectively. Israel, to this day, maintains a division of 5 on each table. These 10-linen curtains represent the law in the 10 commandments. Coupled together, they form ONE Tabernacle. "Think not that I am come to destroy the law, or the prophets: I am not come to destroy, but to fulfil." Matt. 5:17. "Master, which

is the great commandment in the law? Jesus said unto him, Thou shalt love the Lord thy God with all thy heart, and with all thy soul, and with all thy mind. This is the FIRST and great commandment. And the SECOND is like unto it, Thou shalt love thy neighbour as thyself. On these TWO commandments hang all the law and the prophets." Matt. 22:36-40... two great curtains of five each.

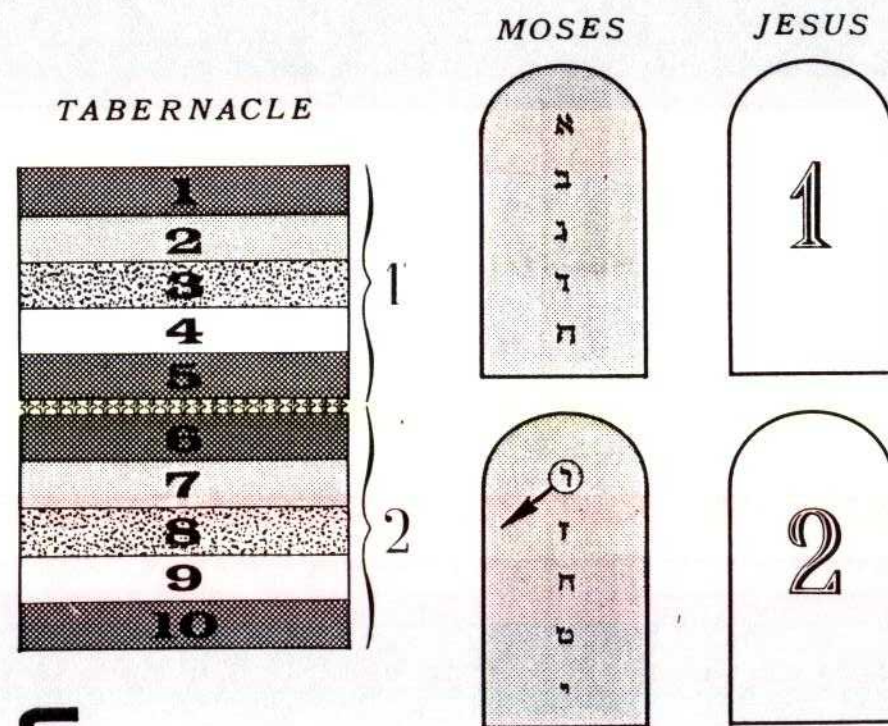

The Hebrew א denotes the 6th commandment, "THOU SHALT NOT KILL". Ex. 20:13. This letter has been found on old Hebrew coins and gems in two striking forms.



"As Moses lifted up the serpent in the wilderness, even so must the Son of man be lifted up." John 3:14.

"For the law was given by Moses, but GRACE and TRUTH came by Jesus Christ." John 1:17. "For what the law could not do, in that it was weak through the flesh, God sending his own Son in the likeness of sinful flesh, and for sin, condemned sin in the flesh." Rom. 8:3. "For Christ is the end of the law for righteousness to every one that believeth." Rom. 10:4. "Wherefore the law was our schoolmaster to bring us unto Christ, that we might be justified by faith." Gal. 3:24. "Blotting out the handwriting of ordinances (the 10 commandments written with the finger of God, representative of the whole law) that was against us, which was contrary to us, and took it out of the way, nailing it to his cross." Col. 2:14. The Tabernacle testifies to the complete and perfect work of Calvary. "And the Word was made flesh, and TABERNACLED among us." John 1:14.

Gershon was assigned the care of the tent. This was the TWO-sectioned goats' hair tent representing sin. Number ONE, "Without shedding of blood is no remission." Heb. 9:22. This is the Lord's goat in type. Number TWO, "Their sins and iniquities (confessed on the scapegoat in type) will I remember no more." Heb. 8:12. This tent was directly on the Tabernacle covering, even so was our sin placed on the Lord Jesus. "---The Lord hath laid on him the iniquity of us all." Is. 53:6.

The family of Gershon also bore the covering of rams' skins dyed red. This covering completely covered the tent of goats' hair. The blood of Jesus Christ covered all our sin. Dimensions are given for the Tabernacle covering for these things were limited. Christ came to die only once. "It is finished." John 19:30. Dimensions were given for the goats' hair tent, for sin will someday be brought to an end. Not a single dimension is given for the covering of rams' skins dyed red for there is no limit to the saving power of the blood of Jesus Christ.

The covering of skins dyed blue was also carried by the Gershonites.....a picture of God the Father as He dwelt in the midst of Israel. The Gershonites carried the hanging

for the door of the Tabernacle of the Congregation. This was the first veil hung upon 5 pillars overlaid with gold, on brass sockets, but with gold crowns. While the veil, again, represents the Lord Jesus, this veil represents Jesus as shadowed in the law.....five pillars, five books of the law, standing on five brass sockets. Brass has generally been understood to stand for judgment in the light of the brasen serpent. The basis of law was a life for a life. Yet, the five pillars had capitals of gold as the law was fulfilled in Christ. We will return to this veil, but, remember, it speaks directly of the law.

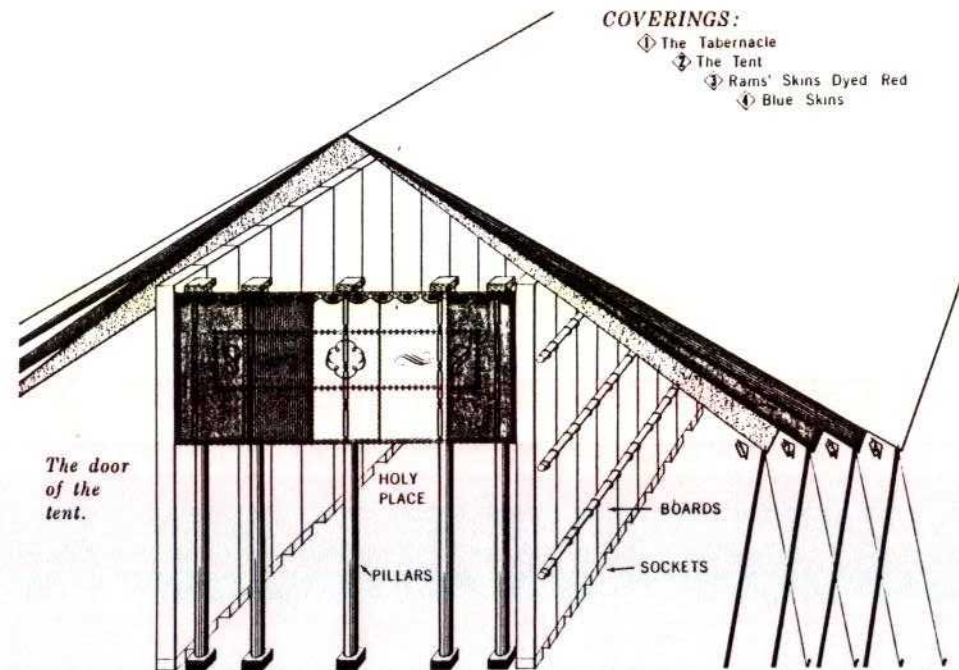

Still more was assigned to the Gershonites, the hangings of the court and the beautiful hanging for the court gate. The white linen spoke of the righteousness of the Lord Jesus, but again, the gate spoke of Jesus Christ. The high, white linen fence excluded everyone. A negro spiritual

puts it this way, "So wide you can't go around it, so high you can't go over it, so low you can't go under it, you must come in at the door". "I am the door: by me if any man enter in, he shall be saved, and shall go in and out, and find pasture." John 10:9.

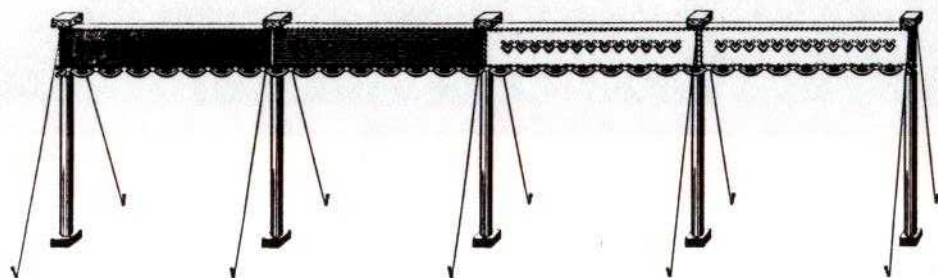

These were the items in the charge of the Gershonites, and as they assembled their part each time, it told them a story. They were kept out by righteousness.. righteousness required by a Holy God. But the gate was the Righteous One who supplied the required righteousness, and was The Way. They stretched out the Tabernacle curtain, even as Jesus was stretched out on Calvary's Cross. They laid on the goats' hair tent of sin, their sin, and covered it with the rams' skins dyed red... blood, His blood. Over the top went the blue skins, and then they stood looking up and whom did they see? Yes, they saw Him, their Messiah, dying for them. Then, when the boards were in place they hung up the first veil, The Truth. "Thy law is truth." Ps. 119:142. "O how I love thy law! it is my meditation all the day." Ps. 119:97. "Open thou mine eyes, that I may behold wondrous things out of thy law." Ps. 119:18. "Great peace have they which love thy law: and nothing shall offend them." Ps. 119:165.

The sons of Merari were assigned the 48 boards. These boards made up the sanctuary itself, that is, the holy place and the holy of holies.... A shadow body of the Lord Jesus and a picture of the refuge we have in Jesus Christ as we have already seen. The family of Merari was also assigned the bars, the pillars, and the sockets of the sanctuary. Nearly 5 tons of silver was placed as a foundation to keep the gold boards off the ground.

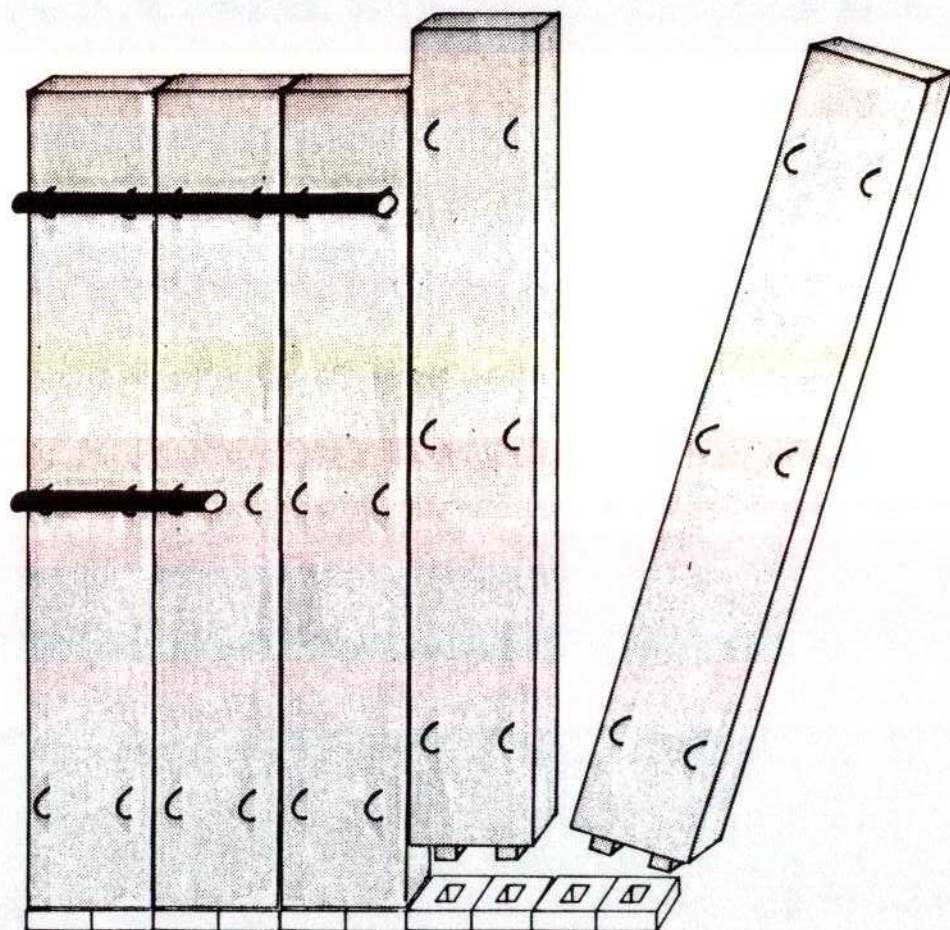

Much of the shadow in the boards was not revealed to the Israelites. The boards represented a new body for the Lord Jesus. This new body was not even going to exist until Jesus had died on Calvary. It is true that silver spoke to Israel of redemption and atonement and pointed to the death of Jesus for their sin. Not until the Holy Spirit came to dwell in the believer, did the sanctuary take on its true meaning. Then, in the light of Paul's letter to the Ephesians, things became more clear. Believers "are built upon the foundation of the apostles and prophets, Jesus Christ himself being the chief corner stone". Eph. 2:20. This is not to give the idea that the apostles and the prophets are the foundation. Let us read further, "In whom all the building fitly framed together groweth unto an holy temple in the Lord: In whom ye also are builded together for an habitation of God through the Spirit." Eph. 2:21,22. This building then is made up of the apostles and New Testament prophets and all believers. The foundation is the silver, the redemptive work of Jesus Christ. "Forasmuch as ye know that ye were not redeemed with corruptible things, as silver and gold, from your vain conversation received by tradition from your fathers; But with the precious blood of Christ, as of a lamb without blemish and without spot." 1 Peter 1:18, 19. We become part of this building through the blood of the Lord Jesus Christ. This, then, is His body, the church. But all of this was unknown to Israel. "Which in other ages was not made known unto the sons of men, as it is now revealed unto his holy apostles and prophets by the Spirit; That the Gentiles should be fellowheirs, and of the same body, and partakers of his promise in Christ by the gospel." Eph. 3:5,6. The family of Merari put in 5 bars on the north side, 5 bars on the south side, 5 bars on the west end, and 5 pillars at the door. This was the "shadow body" under the law. And they erected only 4 pillars between the holy place and the holy of holies to hold the second veil. In the Old Testament, the gospel lies, for the most part, in the five books of Moses. In the New Testament, it is the first four

books that present the gospel. Thus, four pillars, Matthew, Mark, Luke, and John, hold aloft the message of eternal life "through the veil, that is to say, his flesh". Heb. 10:20. As the 5 pillars at the door stood on brass sockets of judgment, so these 4 pillars stand on silver sockets, the redemptive work of the Lord Jesus.

One further job was part of the work of the sons of Merari, and that was to erect 60 posts around the court. Each post was placed on a brass socket but its capital was overlaid with silver. These posts stood on the brass of judgment but held high the silver which pointed to the shed blood of the Lord Jesus.



YE SHALL BE HOLY:
FOR I THE LORD
YOUR GOD AM HOLY.
Lev. 19:2.

4 Blessed is the man whom thou
choosest, and causest to approach
*unto thee, that he may dwell in
thy courts: we shall be satisfied
with the goodness of thy house,
even of thy holy temple.*
Ps. 65:4



As the sons of Merari assembled the parts entrusted to them, they, too, could see the gospel story. The brass sockets of the court were probably set in place first. Then, the 60 court posts which marked off the holy ground. Sixty

capitals of silver reminded them of God's wonderful deliverance out of Egyptian bondage. They looked at this MEMORIAL and their hearts remembered the blood on the door posts and lintel. How often they thought of that lamb that provided the blood that meant their safety. And those that were spiritual, looked ahead toward the day when God's Lamb would provide eternal safety.

Once the sons of Merari had placed the court posts, the Gershonites could hang up the linen curtain. On the other hand, the Gershonites erected the tent structure before the sons of Merari could assemble the board structure beneath it. First, the sons of Merari set in place the silver sockets, part of the same atonement money which made up the silver for the capitals of the court posts. Then the boards were assembled and held in place by the bars. But they did not know that the boards represented the body of believers. The tent covers were already up when the boards were put under them. First, Jesus died (the Tabernacle), and bore our sin (the goats' hair tent), and covered them with His shed blood (the rams' skins dyed red) and then, and then ONLY could it be said of the Christians, "In whom (Christ) all the building fitly framed together groweth unto an holy temple in the Lord: In whom ye also are builded together for an habitation of God through the Spirit." Eph. 2:21, 22. As God, represented by the blue skins, looks down on the blood (the rams' skins dyed red), covering our sin (the tent) placed on His crucified Son (the Tabernacle) truly His wrath passes over us. "When I see the blood, I will pass over you." Ex. 12:13.

The family of Kohath followed way behind in the line of march. The children of Israel were divided into four camps of three tribes each. The camp of Judah moved out first, then the sons of Gershon and Merari who carried the parts of the Tabernacle so that they could arrive in time to have the structure assembled for the holy furniture. The camp of Reuben came next and then all the remaining persons of the tribe of Levi including the Kohathites who carried the

holy furniture. The camp of Ephraim and the camp of Dan brought up the rear. (Num. 2, 10) Thus, when the Kohathites arrived, everything was in readiness for the items entrusted to them. The Kohathites carried all the furniture, but they also carried one part of the Tabernacle structure. Whenever the children of Israel moved their camp, the priests first covered all of the holy furniture. The priests first lowered the covering veil, that is the veil that divided the holy place from the holy of holies. Keeping it above their heads, so that they did not see the ark of the covenant, they moved forward toward the ark and covered the ark with the second veil. This is the veil that represented the Lord Jesus and it was rent at the time of His death. Next, the ark was covered with blue skins and then with a blue cloth. Each of the other pieces of furniture were likewise covered with two or more coverings. Our Bible does not specifically mention the covering of the laver but this is stated in the Septuagint. Is it not strange that the brasen altar, subject to rain, snow, fire, and all sorts of rough treatment should be covered during the moving? The fire was carefully removed and placed in a censer. Then, a purple cloth was placed over the altar and over that, a blue skin covering. All of the pieces had a final outside covering of blue skins, except the ark, on which the outside covering was blue cloth. Once all of the furniture was covered by the priests, the Kohathites entered to carry out the furniture. Unlike the sons of Merari and Gershon, who were allotted six carts for miscellaneous material, the Kohathites bore every thing on their shoulders. The accompanying drawing will show the furniture arranged in the form of a cross. I believe when the furniture was covered for moving, it presented a great blue cross moving across the wilderness.

The furniture seems to be divided into two groups of three pieces each. We have described in Exodus 25 the ark, the table of shewbread, and the lampstand. In Hebrews 9 we have the same three pieces referred to, but in reverse order. It seems this preferred treatment of these three

TO ESTABLISH THE POSITION
OF THE FURNITURE

Axis---AB ~~~

A. The Ark ★

1. the staves were on the sides (Ex. 25:13)
2. the cherubim were on the ends (Ex. 25:18)
3. the mercy seat faced east (Lev. 16:14)
4. the staves were left in the rings (Ex. 25:15)

Thus, we conclude that the staves ran north and south. The length of the staves and the fact that they were permanently attached, places the ark on axis AB.

B. The Golden Altar ▶

1. was before the veil (Ex. 30:6)
2. was before the ark (Ex. 40:5)
3. was before the mercy seat (Ex. 30:6)

Thus, we conclude the position of the golden altar was also on the axis AB.

C. The Brasen Altar ●

1. was before the door (Ex. 40:6, 29)

The very size of the altar, its being 1/2 the width of the board structure, places it on axis AB.

D. The Brasen Laver ▶

1. was "between" the tent and the altar (Ex. 40:7)

This places the laver on the axis AB. The laver placed to the north or south of this axis, as is often done, would not be "between" the tent and the altar.

Thus, axis AB is established.

Axis---CD ~~~

A. The Table of Shewbread ★

1. was on the north side (Ex. 40:22)

B. The Lampstand ☆

1. was on the south side (Ex. 40:24)
2. was opposite the table (Ex. 40:24)

We therefore have the table and lampstand fixed by scripture as being opposite one another. (also Ex. 26:35)

Scripture does not place the lampstand, the golden altar, and the table of shewbread in a straight line, but neither does scripture place them out of line. Josephus in his ANTIQUITIES, ch. 6, sec. 8 says, "Now BETWEEN this candlestick and the table, . . . was the altar of incense." We have an additional record by Clement of Alexandria who in THE STROMATA, ch. 6 says, "The lamp, too, was placed to the south of the altar of incense. . . . North of the altar of incense was placed a table." We have, then, two historic records that establish axis CD. Evidence thus shows the furniture in the form of a cross.

PLAN VIEW

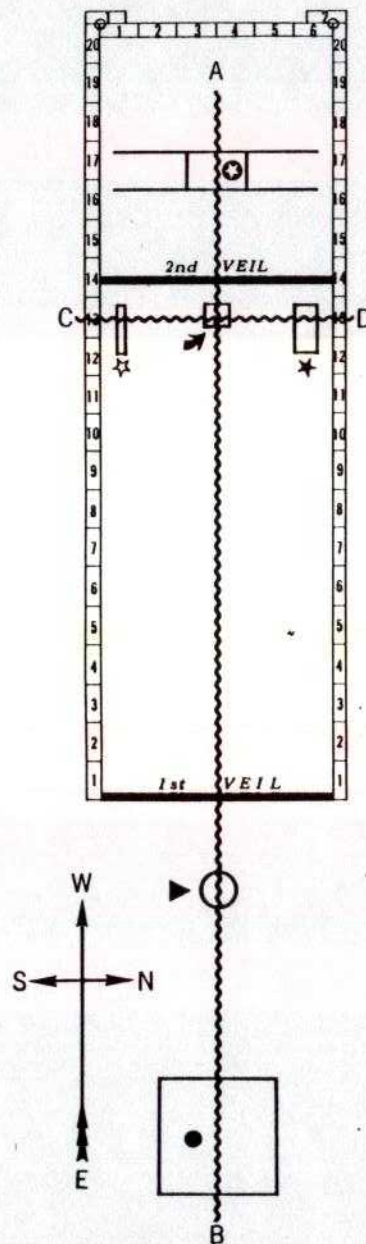

pieces is quite intentional. I propose to call these the three inactive pieces and the altars and laver the active pieces. You might prefer to call the ark, the table, and the lampstand, God's pieces. The remaining three might be referred to as man's pieces. The brasen altar offered a picture story when men brought and offered their sacrifices to God. It was here that the offerings in many and devious ways pointed to Christ. First of all, there were 5 types of offerings: the burnt-offering, the meal-offering, the peace-offering, the sin-offering, and the trespass-offering. There were 5 acceptable burnt-offerings. . . . all picturing Jesus as a willing substitute. The bullock looked to Jesus as the son of Adam, the genealogy as given in the book of Luke. The lamb looked to Jesus as the son of Abraham, the genealogy as given in the book of Matthew. The goat looked to Jesus as the Son of God, the genealogy as given in the book of John. These offerings were killed and cut up and burned upon the altar. The pigeons or doves were not divided; they were not even sacrificed by the one who brought them as an offering. The priest sacrificed the birds for the offerer. Here Jesus is pictured offering Himself because of His love and mercy for us. If you remember, we saw the reference to the shadow body in Psalms chapter 40. In this Psalm it is recorded that Jesus did 5 things in the great congregation of Israel.

"I have preached RIGHTEOUSNESS." Ps. 40:9. The righteousness of God is manifest in the bullock, for He sent His Son to die for the sin of all men. David said, "Then shalt thou be pleased with sacrifices of RIGHTEOUSNESS, with burnt-offering and whole burnt-offering: then shall they offer BULLOCKS upon thine altar." Ps. 51:19. Then, Psalms 40 says, "I have declared thy FAITHFULNESS and thy SALVATION." God's faithfulness in sending His Son is depicted in the goat. God's salvation is shadowed in the lamb. In spite of all of the strictness of the law, it is written in Psalms 40:10, "I have not concealed thy LOVING-KINDNESS and thy TRUTH." I believe these are shadowed in the birds.

AND JOHN BARE RECORD, SAYING, I SAW THE SPIRIT DESCENDING FROM HEAVEN LIKE A DOVE, AND IT ABODE UPON HIM. John 1:32.

10 Mercy and truth are met together; righteousness and peace have kissed *each other*. Ps. 85:10

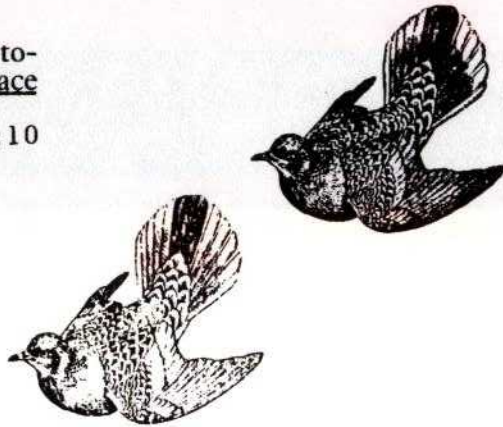

A PAIR of TURTLEDOVES

17 For the law was given by Moses, but grace and truth came by Jesus Christ. John 1:17



TWO YOUNG PIGEONS

Wherefore then serveth the law? Gal. 3:19

The law was our schoolmaster to bring us unto Christ. Gal. 3:24

A shadow of good things to come. Heb. 10:1

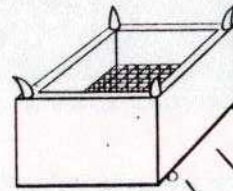

The law of the burnt-offering. Lev. 6;9

The law of the meal-offering. Lev. 6;14

THE LAW OF THE SIN-OFFERING. LEV. 6;25

The law of the trespass-offering. Lev. 7;1

THE LAW OF THE PEACE-OFFERING. LEV. 7;11

Jesus said,

"Had ye believed Moses, ye would have believed me: for he wrote of me. But if ye believe not his writings, how shall ye believe my words?"

John 5; 46, 47

"Think not that I am come to destroy the LAW, or the prophets: I am not come to destroy, but to fulfil."

Matt. 5; 17

Christ is the end of the law. Rom. 10:4

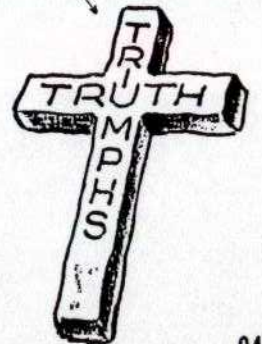

The law was given by Moses, GRACE and TRUTH came by JESUS CHRIST.

John 1:17

When sacrifices were not being offered, the altar showed very little if any picture. The brasen laver meant little until the priest washed his hands and feet, and thus enacted a picture. The golden altar, while sometimes a place of refuge, was almost without meaning until the priest offered the incense, "which are the prayers of saints". Rev. 5:8. It then points to the great intercessory prayer of our High Priest in John 17. In other words, these three pieces require acts by men to work out the picture. This is not true in the other three pieces. The ark always pictured God's throne in the midst of His people. The high priest could always come here, remaining just outside the veil, and receive God's directions. The lampstand offered a constant picture as we have seen. True, men kept it refueled but that was simply a mechanical necessity. The table of shewbread also presented a continual picture. The bread on this table was never eaten until it was replaced with fresh bread. Every Sabbath, fresh bread was put on the table. This bread was made by the Kohathites. "And other of their brethren, the sons of the Kohathites, were over the shewbread, to prepare it every sabbath." 1 Chr. 9:32. This bread was actually an unleavened perforated cake which is the meaning of the Hebrew word cake, in Leviticus 24:5. "And thou shalt take fine flour, and bake twelve cakes thereof: two tenth deals shall be in one cake. And thou shalt set them in two rows (piles), six on a row, upon the pure table before the Lord. And thou shalt put frankincense upon each row, that it may be on the bread for a memorial, even an offering made by fire unto the Lord. Every sabbath he shall set it in order before the Lord continually, being taken from the children of Israel by an everlasting covenant. And it shall be Aaron's and his sons'; and they shall eat it in the holy place: for it is most holy unto him of the offerings of the Lord made by fire by a perpetual statute." Lev. 24:5-9. Now this bread stood in the light of the lampstand. The table and lampstand were opposite each other. (Ex. 26:35) The lampstand was probably turned

parallel to the gold boards so that the gold boards acted as a reflector, causing the light of the lamp to be thrown toward the table. It was necessary that there be this gold reflector to cause the lamps to shine in one direction. "Speak unto Aaron, and say unto him, When thou lightest the lamps, the seven lamps shall give light in front of the candlestick (lampstand)." Num. 8:2 ASV. These cakes are part of this great parable and must be understood as such. Their true significance seems so veiled it is difficult to understand. Israel is even today blinded in regards to these spiritual truths. "According as it is written, God hath given them the spirit of slumber, eyes that they should not see, and ears that they should not hear; unto this day. And David saith, Let their table be made a snare, and a trap, and a stumblingblock, and a recompence unto them." Rom. 11:8,9. To what table does David refer? He does not say their tables, plural, but rather a table. This reference is to Psalms 69:21,22. "They gave me also gall for my meat; and in my thirst they gave me vinegar to drink. Let their table become a snare before them: and that which should have been for their welfare, let it become a trap." Now notice that this reference to the table occurs in reference to the suffering of the Lord Jesus on Calvary.

The fact of 12 loaves on the table of shewbread links the bread with the 12 tribes of Israel. Therefore, regardless of the meaning of the bread, we know that the whole nation of Israel is included. We also note that these cakes are made of fine flour without leaven. This is the same type of cake Israel used on the night of the first passover. They are called, "an offering made by fire". Lev. 24:7. On the top of each pile was placed frankincense for a memorial. I believe these 12 cakes were a memorial of that passover night when the first passover lamb died and the blood was put on the door posts and lintel. This same cake was used by Jesus at the last official memorial of the passover in Egypt. "And when he had given thanks, he brake it, and said, Take, eat: this is my body, which is for you: this do in remembrance

of me." 1 Cor. 11:24. These cakes then typify Jesus Christ. They are made of fine flour, without leaven. Leaven in scripture always represents sin, and Jesus was without sin. In order to make the unleavened cakes bake properly, they pierced them with many small holes. These holes typify the suffering of Jesus; His thorn-pierced brow, His wounded hands and feet, His pierced side. These cakes were a memorial of the first passover and a prophecy of the second. "For even Christ our passover is sacrificed for us." 1 Cor. 5:7. Why 12? Because Jesus was delivered over by the 12 tribes of Israel and it was for Israel He died. "For I am not ashamed of the gospel of Christ: for it is the power of God unto salvation to every one that believeth: to THE JEW FIRST, and also to the Greek." Rom. 1:16. "The God of Abraham, and of Isaac, and of Jacob, the God of our fathers, hath glorified his Son Jesus; whom YE DELIVERED UP, and DENIED him in the presence of Pilate, when he was determined to let him go." Acts 3:13. Thus, the 12 cakes pointed to the sinless, suffering Savior. It was intended for Israel's good but sin turned it into a TRAP, a STUMBLINGBLOCK, a SNARE, and a RECOMPENSE. The passover table of Israel of which this shewbread was a continual memorial, is the table to which Paul refers in Romans.

During the passover celebrations today, there is a three-pocket cover placed on most Jewish tables. Into each of these pockets is placed a piece of this unleavened, perforated cake. What does this three-pocket cover with its pieces of perforated cake represent? You might get many answers, for there is no consistent answer. Israel is blinded, and does not know the real answer. As the celebration continues, the middle pocket is opened, the cake removed and broken and then hidden, often between two pillows. When the supper is ended, the piece of broken cake is removed from wherever it was hidden and broken into small pieces so that every person present may have a piece. If Israel could only see. This perforated cake

represents Jesus just as it always did. The three pieces in the one cover represent the Father, Son, and Holy Spirit. It is the middle piece that is broken, the Son who was crucified. The broken piece is put between two pillows, even as Jesus was buried. But then the cake is removed even as Jesus rose from the grave. The cake is broken. "Take, eat, this is my body, which is for you." 1 Cor. 11:24. But Israel does not know. Notice how carefully they moved the table of shewbread. First, they removed everything and covered the table with a blue cloth and replaced the shewbread. This was the suffering Lord from heaven. Then, they covered the bread with a scarlet cloth. It was Israel's sin that hid Christ from their view. "Come now, and let us reason together, saith the Lord: though your sins be as scarlet, they shall be as white as snow." Is. 1:18. And it was the blood of Jesus that flowed from those wounds in His hands, His feet, His back, His brow, and His side. And finally, over all they placed the blue skins, even as the Son was in the Father. "I and my Father are one." John 10:30.

As the Kohathites arrived at the scene of the next encampment, all was in order for them to put the furniture into location. Then the priests uncovered the ark. They removed the blue cloth, then the blue skins, and then careful not to see the ark of the covenant, they took off the covering veil. With the veil above their heads they walked backward to the four pillars and drew up the covering veil into position. As long as this veil was between the holy of holies and the priests, they were safe. This veil did not so much keep the people out (it did do that) as it kept God's wrath from the people. Remember: this veil represents Jesus Christ and persons without Christ are under God's wrath. "He that believeth on the Son hath everlasting life: and he that believeth not the Son shall not see life; but the wrath of God abideth on him." John 3:36.

AS MOSES TOLD THE STORY TO AARON

We have by no means exhausted the study of the Tabernacle. First, it is essential that we have our understanding of the construction of the Tabernacle as nearly like the description in the Word of God as possible. Second, it is necessary to understand a little of the sacrificial system. Third, it is important to know something about the garments of the high priest. The purpose of this book has been to endeavor to lay a foundation in these things. We will now try to understand a few of the spiritual truths as they were enacted in the great drama. I believe Moses and Aaron understood many of these truths. May I impersonate Moses and ask you to imagine yourself as Aaron the first high priest? Imagine that I am telling you what God instructed Moses to tell Aaron, for God said to Moses, "Thou shalt be to him (Aaron) instead of God". Ex.4:16. And again, "Speak unto Aaron thy brother, that he come not at all times into the holy place within the veil before the mercy seat, which is upon the ark; that he die not: for I will appear in the cloud upon the mercy seat". Lev.16:2.

Remember, dear reader, you are Aaron, and I wish to explain to you in the light of the New Testament, the most important structure ever built on earth. I wish to guide you through the most unusual dwelling ever erected, and to explain a little of the most amazing drama ever enacted. Come! See Aaron, there it is at last. It has been a little more than 6 months in building. Imagine, Aaron, our having a miniature of the great Heavenly Tabernacle...one that we can move all over the desert. But, Aaron, I assure you, its glory does not compare to the Heavenly Tabernacle which I saw...but it is beautiful, isn't it? From this dis-

tance you can see the beautiful blue tent. My but it surely matches the sky. And then to think, Aaron, God is going to dwell here in the midst of Israel. Now you understand what you are to do. You are going to represent Israel's Messiah and act out God's plan for our salvation.

We are getting near the gate, Aaron. Look at those beautiful colors. Look at that white linen curtain all around the court; it is so white, the workmen really did a good job. It surely doesn't represent our righteousness, does it, Aaron? Ours is as filthy rags, but that is the Messiah's righteousness. Some day you and I will be clothed with the righteousness of God. It seems impossible, doesn't it, Aaron? See those shining silver capitals. They are pretty, but they make me tremble with fear every time I see them. Wasn't that a terrible night when we left Egypt with all the crying of the Egyptians when their sons were slain. At least a few of them listened and believed God and put the blood on the door posts and lintel as we did. God delivered us from human bondage then. Someday, He must come in the person of His Son to die on the cross, betrayed for 30 pieces of silver, to redeem us from bondage to sin and death. He told me about the betrayal when I was with Him those 40 days in the mountain. We each put one-half a shekel into the silver offering, but He will be betrayed for 30 shekels...60 times as much. That is why we have the 60 posts. That is a terrible price to pay, Aaron, and you know we are not worth it. But He explained that we could never occupy the Heavenly Tabernacle until He died for our sin. Then we talked about how few of Israel really cared and I saw the tears come in His eyes. My how He loves us. Here we are at the gate.

The blue, Aaron...what a heavenly blue. He told me when I was with Him how they would beat Him and clothe Him in a white robe, then a purple robe, and finally a red robe. That is to show that He is the door. There is no other way in but through this one gate.

There is the brasen altar, not very large, is it? It

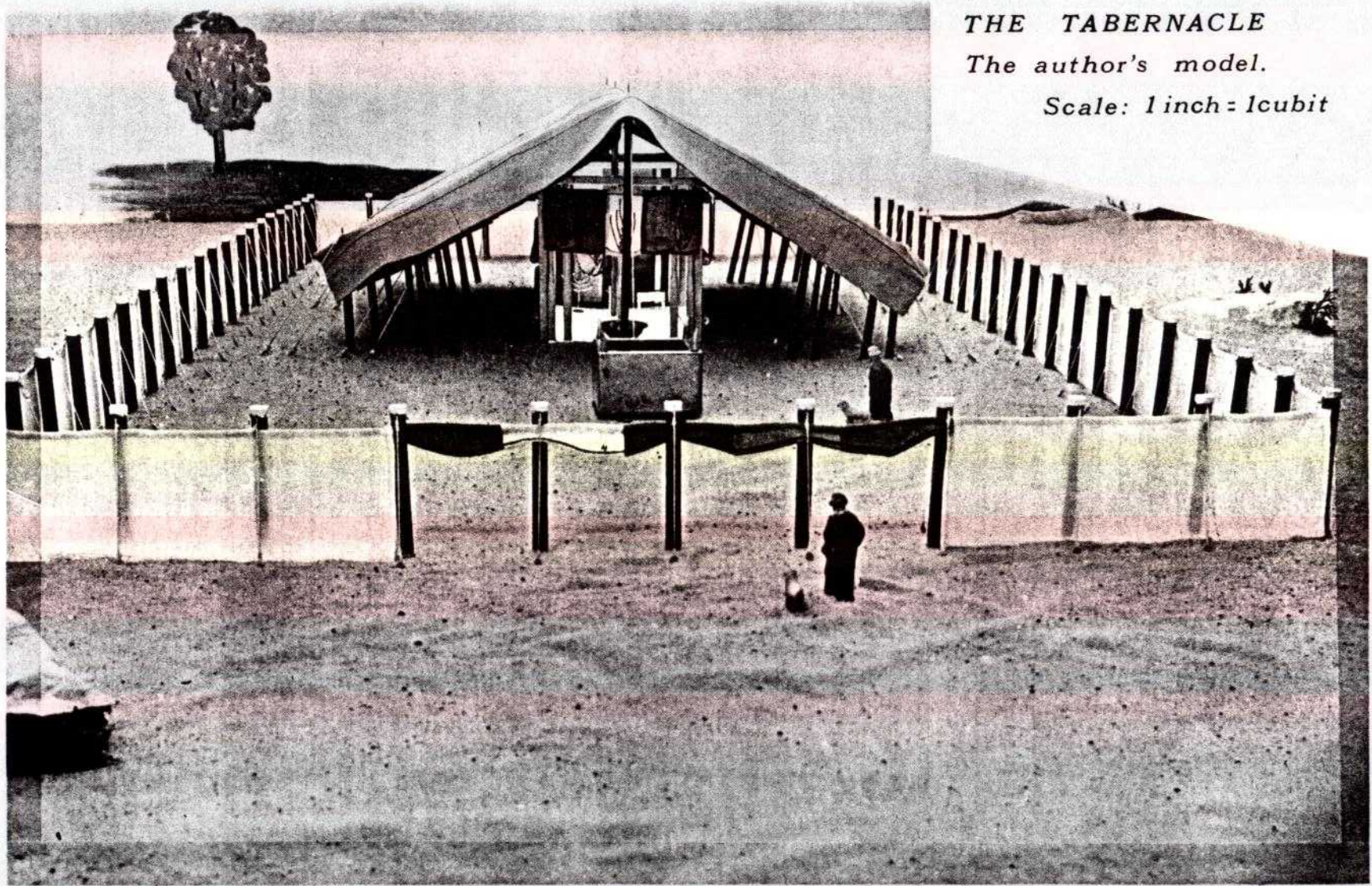

THE TABERNACLE

The author's model.

Scale: 1 inch = 1cubit

looks as though the children of Israel are not going to overload us with offerings. Here, every morning, you, Aaron, or your sons must sacrifice a male lamb without spot or blemish. First, it will point back to our passover in Egypt. You know how docile and helpless a lamb is; that will show the willingness of our Messiah to come as a willing substitute for our sin. Every time we watch you kill it, we will remember how He must die for us.

This is the brasen laver, here you must wash your hands and feet before every offering and each time you go into the sanctuary. Look at the beautiful hanging there at the entrance to the sanctuary, but look up, Aaron. See over our heads the beautiful Tabernacle itself. That Tabernacle is representative of our Messiah stretched out on Calvary's cross? Oh! I forgot to tell you about Calvary's cross. He told me so many things when I was with Him those 40 days. Aaron, you remember when I took that brasen serpent and raised it on the pole? That was to display the terrible thing that would be done to our Messiah. It is hard to believe that anyone would crucify God's Son, but they will. Look up beyond the Tabernacle...see the goats' hair. That is representing our sin placed on the Messiah. But have no fear, Aaron, see, it is covered by the rams' skins dyed red. Those skins represent the blood of our Messiah. I have already told you that the life of the flesh is in the blood, and it is the blood that makes atonement for the soul. See the gold capitals on these 5 pillars holding this veil up. By the way, Aaron, this veil represents the law and the 5 books that I am writing now by the direction of God's Holy Spirit. Let us go into the holy place.

My, but these boards shine; you can hardly look at them. There are the silver sockets. They surely are heavy. That is more of the silver memorial of our great deliverance. These boards puzzle me. When we get into the land, the Levites will be given 48 cities just as there are 48 boards. Then, too, we will have 6 refuge cities just like those 6 boards at the west end. But, Aaron, when I was with Him,

He told me I could not know all about the boards. He said He had reserved a great part of that story to be revealed by a man named Paul.

Just look at that lampstand! It is even more beautiful standing here than when the men were working on it. It surely will look nice when you light those lamps. That light will represent the law now, but one day it will be a token of the Messiah, the True Light. There is the golden altar where you will burn the incense...our prayers going up before God. You must have the Kohathites make 12 unleavened, perforated cakes and put them on the gold table. These cakes will remind us of Egypt, the night we came out. Then, too, the cakes will remind us of the coming of our Messiah to suffer and die for us.

That great veil, Aaron, is the covering veil. You and your sons must lower it very carefully to cover the ark every time we move. Now, remember, your sons must not see the ark. That veil is a picture of our Messiah as He stands between God and us. When I was on the mountain I asked to see the Father. I was warned that I could not look on God's face and live. He covered me with His hand and let me just catch a glimpse of His glory. Aaron, you have no idea of that kind of glory. I was afraid...I was awed...I was thrilled...I just can't explain it. You know how I have to wear this veil on my face now because the radiance of my face frightens the people. And to think, I only caught a glimpse of His glory. What will it be like to live in His presence eternally? This veil on these 4 posts represents the life we have in the Messiah. He told me on the mountain how He would make this very plain to future generations. He said that exactly at the same hour He died He would tear this great veil from top to bottom. Until then, Aaron, you must keep it between you and your sons and the ark. Come past the veil, this will be the last time you can come into the holy of holies except on the day of atonement. There is the ark, beautiful isn't it? It is as close as I could have the men make a copy of the one in heaven, God's throne. God

is going to dwell there between the cherubim. Come let us get ready. Here are your garments. Put on these breeches and this embroidered coat. Now put on the robe of the ephod. See the pomegranates and bells. The pomegranate is the fruit of the tree of knowledge of good and evil that was in the Garden of Eden. They are colored, Aaron, because they show the cost of sin to our Messiah. Blue, because He must leave heaven; purple, because He will come and be rejected as Israel's King. You know, Aaron, I just don't understand how anyone could reject Him. You remember how He ate with us on the holy mountain. Then, that scarlet pomegranate, Aaron... imagine driving nails through His hands and feet. Imagine shedding His blood on a cruel cross. The blue robe will remind us that He is coming to live among His people. Now the ephod: this, too, represents His death. But, Aaron, look at this! Isn't this beautiful! It is the breastplate of judgment. One day He will judge with a righteous judgment. Now for your mitre. Look at the gold crown; it is only because you wear this crown that you can enter the holy of holies on the day of atonement. All the guilt and sin of Israel will be forgiven and we will be accepted in you. That surely will make it plain to the people that we are only accepted by God through His Son, our Messiah. These are your garments of glory and beauty. On the day of atonement you will wear this garment in the morning. These clothes will show the glory of the Messiah, the glory that He has with the Father. The morning sacrifice will be offered as usual. Then you will change to your set of white linen garments. This will picture the Messiah leaving His glory with the Father and coming as the sinless Son of God into a sinful world. Next, you must offer a bullock for a sin-offering. This will be for yourself, for even though you are the high priest, you are a sinner. At the same time it will show the Messiah's coming to die for all sin from Adam until now. Then, you will offer two goats as one offering. You will cast lots on these goats. One will be the Lord's goat. This goat you must kill, and

sprinkle the blood once on the mercyseat of the ark. By doing this you will picture the Messiah offering His blood ONCE for all. Then after you have confessed the sins of Israel on the other goat, it will be let go in the wilderness. This will picture the resurrection of the Messiah, for after He is crucified He will be raised from the dead. After this you can change your garments back to those of glory and beauty. This will picture the resurrected Messiah restored to His former glory.

It is time! Aaron, light the lamps. Today is the first day of the first month. Offer the incense. Let us go to the brasen altar to offer the lamb for a burnt-offering. Your sons have already put on the wood. "Return, O Lord, unto the many thousands of Israel." Num. 10:36. Look Aaron! See the pillar of cloud moving to a position above the Tabernacle. See, it is slowly descending. Now it rests on the tent. Shout! Israel, shout! God has taken up His dwelling in the holy of holies. God has seen fit to dwell in the midst of Israel. "---When all the people saw, they shouted, and fell on their faces." Lev. 9:24.

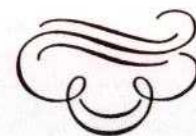

THE END OF THE LAW

The shadows of the Lord Jesus in the Tabernacle are endless. "The LAW had a SHADOW of the COMING GOOD THINGS." Heb. 10:1. All of the offerings, all of the garments, and all of the Tabernacle itself form one great pageant in which Jesus Christ is presented to Israel and to the church.

Nearly 1500 years passed, "And the Word was made flesh, and tabernacled among us, (and we beheld his glory, the glory as of the only begotten of the Father,) full of grace and truth". John 1:14. Jesus dwelt in the midst of His people. He came to die.....that is WHY He came. He explained many things to His disciples. Then one day He said to them, "Let not your heart be troubled: ye believe in God, believe also in me. In my Father's house are many mansions (rooms): if it were not so, I would have told you. I go to prepare a place for you. And if I go and prepare a place for you, I will come again, and receive you unto myself; that where I am, there ye may be also. And whither I go ye know, and the way ye know". John 14:1-4. And Thomas interrupted Him and said, "Lord, we know not whither thou goest; and how can we know the way"? John 14:5. The earthly Tabernacle required a lamb for a burnt-offering to operate at all...so did the Heavenly one. The earthly Tabernacle needed a high priest to make the atonement for Israel.....the Heavenly Tabernacle, too, needed a High Priest. When they reached the promised land, the priests occupied the rooms under the overhang of the tents of the Tabernacle....the Heavenly Tabernacle has this same kind of rooms. Jesus was explaining to the disciples that he was going to Calvary's cross as God's Lamb. That He with His blood would be the High Priest of

THE TRUE TABERNACLE

NEEDED:-

1. A Sacrifice
2. A High Priest
3. A Priesthood

HAD:-

Abiding-places

I GO

to prepare a place → The High Priest
for YOU. → The Priesthood

John 14:2

"Blessed be the God and Father of our Lord Jesus Christ, who hath blessed us with all spiritual blessings in the heavenlies in Christ. ...

To the praise of the glory of his grace, wherein he hath made us accepted in the beloved. In whom we have redemption through his blood, the forgiveness of sins, according to the riches of his grace.

Even when we were dead in sins, (God) hath quickened us together with Christ, (by grace ye are saved;)

And hath raised us up together, and made us sit together in the heavenlies in Christ Jesus: ...

Now therefore ye are no more strangers and foreigners, but FELLOWCITIZENS of the HOLY PLACES." Eph. 1:3, 6, 7; 2:5, 6, 19.

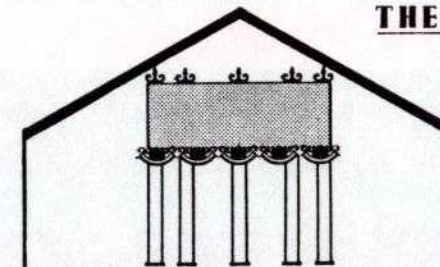

THE EARTHLY TABERNACLE

had:-

- A Sacrifice
- A High Priest
- A Priesthood

IT IS FINISHED John 19:30

The things concerning me

have an end. Luke 22:37

Christ is the end of the law.

Romans 10:4

**A NEW and
LIVING WAY -
through the VEIL -
HIS FLESH.** Hebrews 10:20

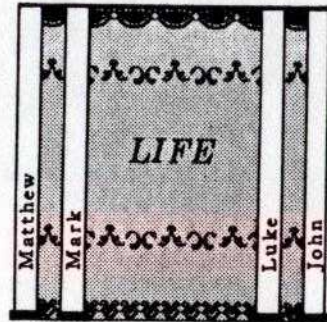

SILVER SOCKETS
REDEMPTION

the Heavenly Tabernacle and then the royal priesthood (the believers) could take up their abode in the Heavenly rooms. Jesus explained it further to Thomas, for He said, "I am the WAY (the court gate), the TRUTH (the first veil), and the LIFE (the rent veil): no man cometh unto the Father, but by me". John 14:6.

We are told of those coming out of the great tribulation that, "-----he that sitteth on the throne shall spread his tabernacle over them". Rev. 7:15. ASV.

This Tabernacle of Witness, or Tabernacle of Proof is hated by Satan. Why? Because man could never have invented a parable so involved as to occupy hundreds of years of history and have a literal fulfilment in a person. It is PROOF of the Word of God. It is written of the Anti-Christ, "And he opened his mouth in blasphemy against God, to blaspheme his name, AND HIS TABERNACLE, and them that dwell in (tabernacle in) heaven". Rev. 13:6.

All the furniture pictured in the cross one day became a cruel reality. "And I, if I be lifted up from the earth, will draw all men unto me. This he said signifying what death he should die." John 12:32, 33.

But after Jesus had died on that cruel cross, we read, "But one of the soldiers with a spear pierced his side, and forthwith came there out BLOOD and WATER." John 19:34. Immediately in the next verse we read a statement that would seem to indicate that the Apostle John was greatly moved. He had seen something so startling, he insists upon his own truthfulness; for what he recorded was, to a human being, absolutely impossible! "And he that saw it bare record, and his record IS TRUE: and he knoweth that he saith TRUE, that ye might believe." John 19:35.

BLOOD and WATER flowed down when the soldier's spear pierced the side of the body of the Lord Jesus. Now notice, "He was dead already." John 19:33. He had been dead, perhaps, an hour, maybe two. As the spear pierced either the stomach or the bladder, a quantity of WATER flowed. Once the heart stops, no blood flows. Here, even

**Thy
LAW
is
TRUTH.**

Psalms 119:142

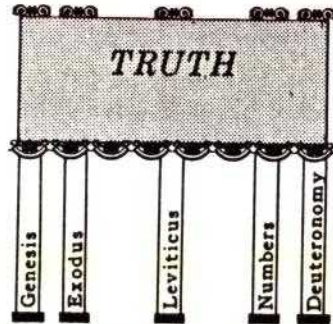

BRASS SOCKETS - JUDGMENT

**Thy
WORD
is
TRUTH.**

John 17:17

**Neither by the blood
of goats and calves,
but
BY HIS OWN BLOOD.**

Hebrews 9:12

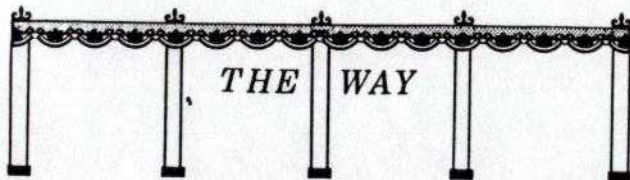

John 14:6

A SHADOW

NO LONGER

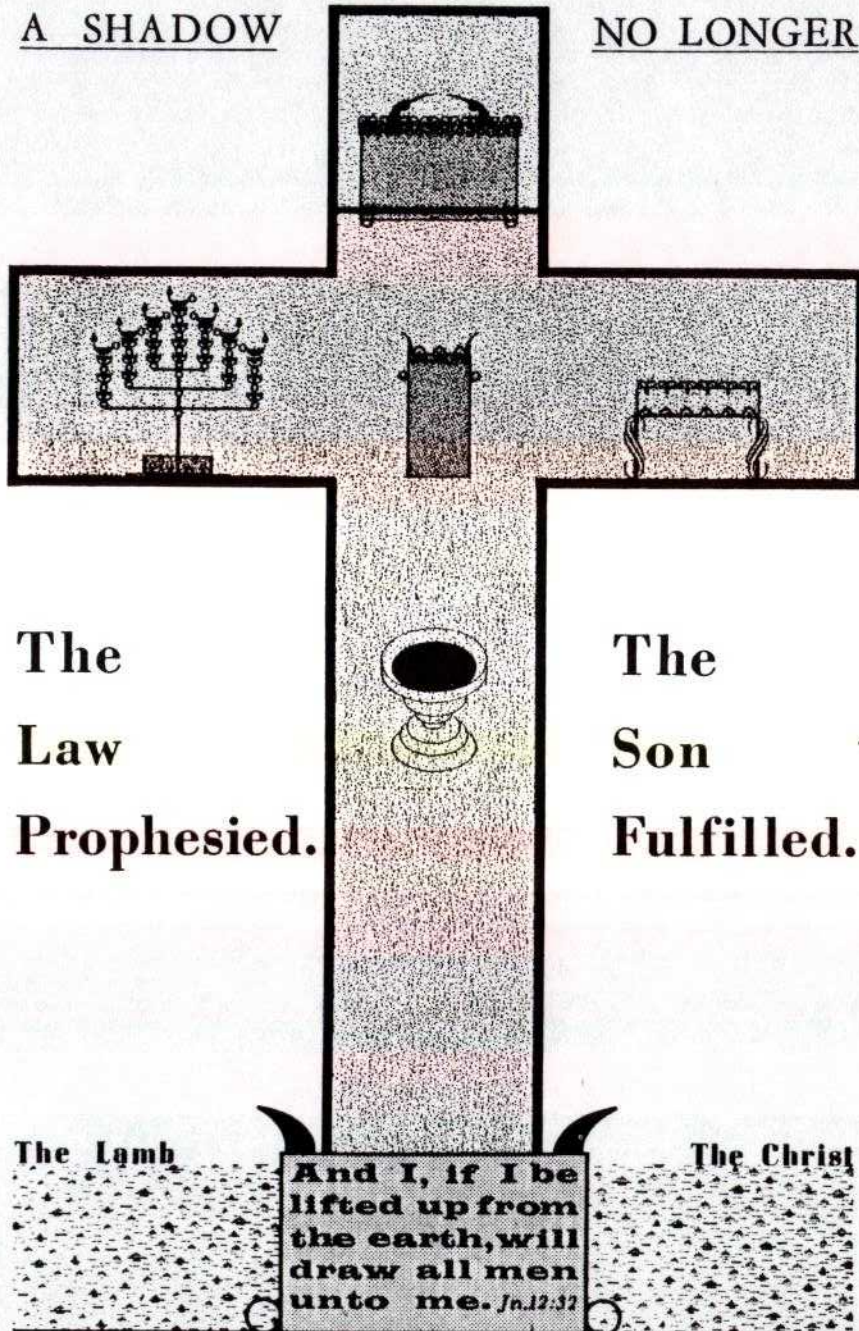

though death had come sometime ago, as the spear pierced the side, BLOOD likewise flowed. This could not happen in a human being. The conclusion: indeed, this man was not merely man but GOD-MAN. He had deliberately laid down His own life. "I lay down my life, that I might take it again. No man taketh it from me, but I lay it down of myself. I have power to lay it down, and I have power to take it again. This commandment have I received of my Father." John 10:17, 18. "He dismissed His Spirit." Matt. 27:50. Having laid down His life, He still had to shed His blood, for "without the shedding of blood is no remission." Heb. 9:22 Very little blood came from the wounds made by the nails, but now a flow of blood proved to John that this Man was no ordinary man but the Divine Son of God. These things were written into the record so YOU could BELIEVE.

"The law prophesied until John." Matt. 11:13. For 1500 years THE LAW PROPHESED until Jesus Christ, God's Lamb, God's Son, our Great High Priest fulfilled it all. "Now unto him that is able to guard you from stumbling, and to set you before the presence of his glory without blemish in exceeding joy, to the only God our Saviour, through Jesus Christ our Lord, be GLORY, MAJESTY, DOMINION and POWER, before all time, and now, and forevermore. Amen." Jude 24,25. ASV.



"Search the scriptures; for in them ye think ye have eternal life: and they are they which testify of me. And ye will not come to me, that ye might have life."

John 5:39, 40.

ACKNOWLEDGEMENT

We gratefully acknowledge the help given by Mr. Fred Adams and Mr. Karl David of Garland Bible College, Garland, Texas, and Mr. Wells of Pickens, S.C. in making photographs of the author's model.

BIBLIOGRAPHY

- Arndt-Gingrich, A GREEK-ENGLISH LEXICON of the New Testament, The University of Chicago Press., 1957.
- Berry, George Ricker, THE HEBREW OLD TESTAMENT, Wilcox and Follett Co., Chicago, 1943.
- Charles, R. H., THE BOOK OF ENOCH, London, 1952.
- Edersheim, Alfred, THE LIFE AND TIMES OF JESUS THE MESSIAH, Longmans, Green, and Co., New York, 1899.
- Edersheim, Alfred, THE TEMPLE, Wm. B. Eerdmans Publishing Co., Grand Rapids, Mich., Reprinted 1958.
- Hilop, Alexander, THE TWO BABYLONS, Lölzeaux Bros., New York, 1943.
- Kitto, John, HISTORY OF THE BIBLE, The S. S. Scranton Co., Hartford, Conn., 1905.
- Liddell-Scott, A GREEK-ENGLISH LEXICON, Harper Bros., New York, 1889.
- Newton, Thomas, DISSERTATIONS ON THE PROPHECIES, The Thirteenth Edition, London, 1824.
- Roberts and Donaldson, THE ANTE-NICENE FATHERS, Wm. B. Eerdmans Pub. Co., Grand Rapids, Mich., 1950, "Barnabas", "Clement", "Irenaeus".
- Seiss, Joseph A., THE GOSPEL IN THE STARS, The Muhlenberg Press, Philadelphia, Pa., 1884.
- SEPTUAGINTA, edited by, Alfred Rahlfs, For the American Bible Society.
- SONCINO TALMUD, Berakoth, 32b.
- Smith, William, BIBLE DICTIONARY.
- THE LIFE and WORKS of FLAVIUS JOSEPHUS, Translated by William Whiston, The John C. Winston Co., Phila., Pa.

SCRIPTURE INDEX

SEE CORRELATION BETWEEN HARDBACK AND
LOOSE-LEAF EDITIONS --- LAST PAGE.

<p>Genesis</p> <p>1:1,14.....12</p> <p>3:5..... 150</p> <p>4:4..... 144</p> <p>7:1,2.....143</p> <p>8:11..... 149</p> <p>8:20..... 144</p> <p>9:3..... 153</p> <p>15:2-8..... 147</p> <p>15:6,8,9,10..... 148</p> <p>15:17..... 149</p> <p>18:11..... 149</p> <p>29:33..... 91</p> <p>32:27,28.....90</p> <p>50:26.....33,140</p> <p>Exodus</p> <p>1:22..... 15</p> <p>2:10..... 15</p> <p>3:5..... 156</p> <p>4:16..... 184</p> <p>7:20..... 17</p> <p>11:2,3.....27</p> <p>12:3,5,6,8,22,46.....99</p> <p>12:13.....25,174</p> <p>12:35,36.....28</p> <p>12:42..... 24</p> <p>13:13..... 146</p> <p>16:33..... 140</p> <p>20:13..... 167</p>	<p>21:12-14..... 118</p> <p>21:32..... 113</p> <p>25:9.....26,84</p> <p>25:10,11.....33</p> <p>25:12-16..... 34</p> <p>25:13,15,18.....176</p> <p>25:17-20..... 35</p> <p>25:21,22.....36</p> <p>25:22..... 140</p> <p>25:23-25..... 37</p> <p>25:26-30..... 39</p> <p>25:31,32.....40</p> <p>25:31-39..... 89</p> <p>25:33-40..... 41</p> <p>25:37..... 40</p> <p>25:40.....26,84</p> <p>26:1..... 131</p> <p>26:1-6..... 49</p> <p>26:4,7,8..... 52</p> <p>26:9-13..... 54</p> <p>26:12,14.....55</p> <p>26:15-19..... 58</p> <p>26:16,17.....57</p> <p>26:19..... 119</p> <p>26:20-30..... 59</p> <p>26:20,22,25.....121</p> <p>26:23,24,28..... 57</p> <p>26:26.....127,128</p> <p>26:27.....57,127,128</p> <p>26:30..... 84</p>
--	--

26:31,32.....63
 26:33-35.....64
 26:35.....176,180
 26:36,37.....66
 27:1-8.....44
 27:8.....84
 27:9,10.....64
 27:14,15.....127,128
 27:20.....100
 28:4,6-14,36,38,42.....156
 28:12.....127,157
 28:29.....157
 28:30.....158
 28:32.....161
 28:33-39.....159
 28:35,38.....164
 30:1-5.....46
 30:6.....176
 30:6-10.....47
 30:8.....42
 30:13-15.....29
 30:13.....107
 30:14-16.....108
 30:17-21.....48
 34:28.....16
 35:11.....50
 35:23,25,26.....30
 36:5-7.....32
 36:23,25,27,28,30.....120
 36:33.....57,61
 36:38.....66
 38:8.....29
 38:24.....35
 38:25,26.....108
 38:27,28.....109
 38:29-31.....68
 39:2,3.....30

39:3.....157
 39:33.....50
 40:18.....50
 40:5,6,7,22,24,29.....176

Leviticus

4:5,16.....162
 6:9,14,25.....179
 7:1,11.....179
 9:24.....190
 10:2,6.....161
 11:3,47.....143
 16:2.....184
 16:4.....156
 16:5.....152
 16:14.....176
 16:21.....151
 16:27.....153
 17:11.....106,107,113
 19:2.....173
 21:10.....161
 24:2.....100
 24:2-4.....42
 24:5.....38
 24:5-9.....180
 24:7.....181
 26:3,9,11.....75
 27:8,28,29.....111
 27:8.....116
 27:29.....117

Numbers

2:10.....175
 3:12,13.....92,121
 3:39.....94
 3:39-51.....93
 3:47-49.....106

4:5.....64
 8:2.....181
 8:4.....84
 10:36.....190
 11:16.....16
 12:3.....16
 16:49.....142
 17:8.....41,94
 17:10,12.....142
 31:50,54.....110
 35:6,7,11-14.....123
 35:12.....122
 35:15.....121
 35:25.....122

Deuteronomy

1:23.....16
 9:21.....150
 18:15,19.....20
 21:15-17.....91
 31:9-11,26.....95
 31:12.....96
 33:10.....95
 34:1-4.....76

Judges

1:1,2.....158
 14:18.....149

1 Samuel

3:3.....42,100
 21:6.....37

2 Samuel

7:5-7.....133

1 Kings

1:39-53.....119
 2:28.....119

2 Kings

5:18.....159

1 Chronicles

5:1.....91
 9:32.....180

2 Chronicles

29:7.....96

Job

38:31-33.....13

Psalms

19:1-5.....12
 19:3,4.....13
 22:16.....153
 40:6-10.....126
 40:8.....127,128
 40:9,10.....177
 51:19.....177
 60:4.....76
 65:4.....173
 69:21,22.....181
 78:23-25.....140
 85:10.....178
 119:18.....79,95,170
 119:97.....170
 119:105.....95
 119:142.....95,170,193
 119:165.....23,170
 141:2.....46

Isaiah	
1:18.....	134,183
29:15.....	96
53:6.....	168
53:5-7.....	152
64:6.....	134
66:8.....	76

Jeremiah	
50:11.....	144

Ezekiel	
8:12.....	96
16:10.....	31
22:27.....	144
37:21,26,27.....	75

Hosea	
3:4.....	159
4:16.....	144

Zephaniah	
3:3.....	144

Zechariah	
6:12.....	105
11:12,13.....	114

Malachi	
4:2.....	150

Tobias	
13:11.....	76

2 Machabees	
2:4-8.....	76

Matthew	
2:13,16.....	15
3:11,12.....	96
3:17.....	99,101
4:1,2.....	16
5:17.....	166,179
5:43,44.....	20
8:4.....	19
10:1.....	16
10:6.....	150
11:13.....	99,196
12:3,4.....	37
13:10-13.....	83
17:1-3.....	18
17:5.....	101
17:23.....	17
19:8.....	19
21:5.....	16
22:36-40.....	167
23:2.....	19
26:26,28.....	99
27:5-7.....	112
27:9.....	111
27:18.....	134
27:28.....	135
27:50.....	196
27:51.....	63,133
27:57.....	99

Mark	
1:7,8.....	96
1:11.....	101
1:44.....	19
7:10.....	19
9:2-4.....	18
9:4.....	17
9:7.....	101

10:3.....	19
10:45.....	117
12:26.....	19
14:48,49.....	113
14:61,62,63.....	162
15:17.....	135

Luke	
1:5.....	96
1:5-23.....	46
3:16,17.....	96
3:22.....	101
5:14.....	19
7:28.....	98
9:28-30.....	19
9:30.....	17
9:35.....	101
10:1.....	16
16:29,31.....	19
20:37.....	19
22:37.....	193
23:4,11.....	134
23:11.....	161
24:3.....	17
24:27,32.....	8,77
24:44.....	19
24:44-46.....	77

John	
1:11.....	97,165
1:14.....	125,127,168,191
1:17.....	17,21,168,178,179
1:15-27.....	97
1:29.....	81,99
1:29-36,41.....	97
1:32.....	178
1:36.....	98

2:7-9.....	17
3:14.....	19,167
3:14-16.....	82
3:19-21.....	98
3:27-36.....	100
3:36.....	146,183
5:36.....	101
5:32-37.....	100
5:39.....	78,111
5:39,40.....	196
5:45-47.....	19
5:46,47.....	8,77,179
6:32.....	19
6:49,58.....	140
7:19.....	20
7:19,22,23.....	19
7:37-39.....	129
8:56.....	11,78
10:9.....	170
10:17,18.....	196
10:30.....	183
11:49-52.....	162
12:32.....	195
12:32,33.....	194
14:1-6.....	191
14:2.....	192
17:17.....	193
18:38.....	135
19:2,5,14.....	135
19:4.....	99
19:6.....	193
19:18.....	99
19:24.....	161,162
19:30.....	168,193
19:33-35.....	194
19:36.....	81,99
20:30,31.....	100

Acts	
2:23.....	116
2:30,31.....	78
3:13.....	182
3:13-15,17.....	124
3:22.....	17
3:22,23.....	20
7:44.....	22,82,84,85,87
10:12-15.....	153
10:28.....	154
10:30.....	135
15:21.....	17
17:2,3.....	78
18:28.....	78
Romans	
1:16.....	182
3:25.....	139
5:12,14.....	151
5:14.....	17
7:10.....	142
7:14.....	128
8:3.....	168
10:4.....	168,179,193
10:13,18.....	13
10:18.....	12
11:8,9.....	181
1 Corinthians	
2:9,10.....	84
2:14.....	80
3:11.....	116
3:16,17.....	129
5:7.....	25,80,182
11:24.....	182,183
15:3,4.....	78
15:22.....	151
15:26,54-57.....	142

2 Corinthians	
5:21.....	82,135
8:9.....	160
Galatians	
3:19.....	20,179
3:24.....	168,179
Ephesians	
1:3,6,7.....	192
1:6.....	164
1:22,23.....	130
1:26.....	128
2:5,6,19.....	192
2:11-15.....	136
2:14,15,16-18.....	137
2:19-22.....	114
2:20-22.....	172
2:21,22.....	128,129,174
3:4-6.....	128
3:5,6.....	130,172
Philippians	
2:7.....	111
2:5-8.....	116
Colossians	
2:9.....	125
2:14.....	168
2:17.....	127
1 Timothy	
2:5,6.....	117
Hebrews	
6:18-20.....	124
7:19,25.....	124

8:1-5.....	86
8:2.....	85
8:5.....	3,23,88,125,138
8:12.....	168
9:4.....	34,140
9:5.....	35,87,139
9:9.....	7,22,23,83 86,87,88,128
9:12.....	152,193
9:15.....	20
9:22.....	168,196
9:23.....	85,139
9:23,24.....	86,87
9:24.....	88
10:1.....	125,138,179,191
10:4.....	107
10:5.....	128
10:5-7.....	125
10:20.....	63,65,131 137,173,193
10:19,20.....	124
11:13.....	11
11:24-26.....	10
11:26.....	78
13:11,12.....	153
1 Peter	
1:18,19.....	92,110,172
2:7.....	113

2 Peter	
1:16-19.....	102
1:17-19.....	101
Jude	
9.....	17
14,15.....	11
24,25.....	196
Revelation	
1:12.....	85,87
1:12,13.....	102
3:12.....	129
4:5.....	139,149
5:8.....	180
6:9.....	85,87
7:15.....	194
8:3.....	139
8:3,4.....	46
9:13.....	87
11:19.....	85,87,139
13:6.....	194
15:5.....	3,85,138
15:6.....	135,138,161
15:8.....	138
16:17.....	138
19:8.....	133,135,161
22:13.....	65

